

3RW3 semiconductor motor control unit (soft starter)

Section	Subject	Page
8.1	Specifications/regulations/approvals	8-3
8.2	Device description	8-5
8.2.1	Physical principles	8-6
8.2.2	General device description	8-10
8.2.3	Comparison of the 3RW3 semiconductor motor control unit (soft starter) with the SIKOSTART 3RW22 and SIKOSTART 3RW34 motor control units	8-14
8.2.4	Comparison of the 3RW3 semiconductor motor control unit (soft starter) with the 3RA star-delta combination	8-16
8.2.5	Notes on configuration	8-16
8.3	Application and use	8-18
8.3.1	Areas of application and criteria for selection	8-18
8.3.2	Installation guidelines	8-18
8.3.3	Overview tables: correction factors	8-21
8.3.3.1	3RW30/31 soft starters in a stand-alone installation	8-21
8.3.3.2	3RW30/31 soft starters in combination with the 3RV1 circuit breaker	8-22
8.3.3.3	Combining the 3RT contactor with the 3RU1 thermal overload relay and 3RW3 soft starter	8-24
8.3.3.4	Combining the 3RT contactor with the 3RB10 electronic overload relay and 3RW3 soft starter	8-26
8.3.4	Circuit example	8-29
8.3.5	Commissioning	8-30
8.3.6	Event messages and diagnostics	8-32
8.3.7	Timing diagram	8-33

Section	Subject	Page
8.4	Accessories	8-35
8.5	Mounting and connection	8-37
8.5.1	Mounting	8-37
8.5.2	Connection	8-37
8.5.3	Circuit diagrams	8-38
8.6	Dimensioned drawings (dimensions in mm)	8-41
8.7	Technical specifications	8-42
8.7.1	Control electronics/power electronics	8-42
8.7.2	Short-circuit protection and fuse coordination	8-45
8.7.3	Site altitude	8-50
8.7.4	Specifications in acc. with IEC	8-51
8.7.5	Specifications in acc. with NEMA	8-52

8.1 Specifications/regulations/approvals

The 3RW3 semiconductor motor control units, referred to below more succinctly as soft starters, meet the UL and CSA requirements.

UL/CSA	UL 508
Degrees of protection offered by housings	EN
DIN standard rail	EN 50 022
Electronic Motor control units	IEC 60947 - 4-2
Shock protection	IEC 60947 - 1 and DIN 40050
EMC	IEC 60801 - 4 -2 (draft)
General specifications	EN 602 69 - 1A1
Control devices and switching elements	EN 602 69 - 1A1
Gost	Approved by Gost
CTic	EMC compliance marking for Australia (similar to CE marking)

Table 8-1: Standards, certificates, and approvals, 3RW3

Normal switching duty

The 3RW3 soft starters can be used for normal switching duty in acc. with DIN VDE 0100 Part 460:

A switch for normal switching duty must be provided for all circuits that are to be switched independently of other parts. Switches for normal switching duty do not **necessarily all switch active conductors** of a circuit.

Isolation

The soft starters do not meet the requirements for isolation in acc. with DIN VDE 0100 Part 460 and EN 60 947-1:

Every circuit must be capable of being isolated from the active conductors of the power supply.

Circuit groups can be isolated by a common device if this is permitted by the operating conditions. In the open position, devices with an isolating function must have a corresponding isolating distance and an indicator showing the positions of the moving contacts.

Warnings

	Caution
<p>The devices are all carefully tested at the factory and are not shipped unless they are found to be in proper working order. However, they may be subjected to stresses during transportation over which we have no control.</p> <p>Consequently, the impulse series relays in the main circuit may be in an undefined switching state.</p> <p>In the interests of complete safety, the following procedure should be used at commissioning or after the replacement of the SIRIUS soft starter:</p> <p>First, apply the supply voltage in order to put the impulse series relays in a defined switching state.</p> <p>Then, switch the main circuit on.</p> <p>If you deviate from this procedure, the motor can be switched on inadvertently and cause damage to people or parts of the system.</p>	

	Important
<p>The 3RW3...-1.B1. soft starter was built as a class A device. Using this product in residential buildings could cause radio interference.</p>	

8.2 Device description

The SIRIUS 3RW3 soft starters are part of the SIRIUS modular system. They are compatible with the other SIRIUS switching devices.

The possible combinations are:

- 3RW3 soft starter + 3RV circuit breaker
- 3RW3 soft starter + 3RU/3RB overload relay + 3RT contactor

The link modules used for combinations of contactors and circuit breakers are used for this (see Section 8.3.2, "Installation guidelines").

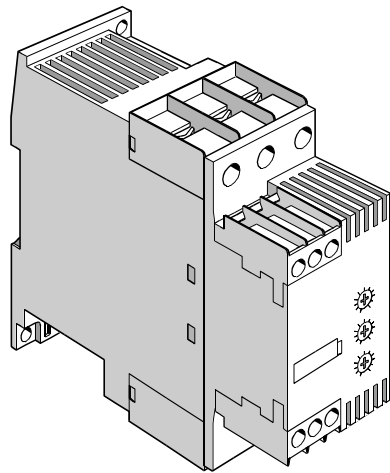

Fig. 8-1: 3RW3 soft starter

3RW30/31 frame sizes

The 3RW30 soft starter is available in four frame sizes: S00, S0, S2, and S3. The 3RW31 soft starter is available in frame size S0.

The following table contains the power ranges of the various frame sizes (all specifications apply to $U_N = 400\text{ V}$ and 40 ° C ambient temperature):

Frame size S00	Frame size S0	Frame size S2	Frame size S3
1.1 - 4 kW	5.5 - 11 kW	15 - 22 kW	30 - 55 kW
6 - 9 A	12.5 - 25 A	32 - 45 A	63 - 100 A
(W x H x D) (mm) 45 x 97.5 x 93	(W x H x D) (mm) 45x125x119	(W x H x D) (mm) 55 x 160 x 143	(W x H x D) (mm) 70x170x178

Table 8-2: 3RW3, frame sizes

8.2.1 Physical principles

Starting current

Three-phase current asynchronous motors have a high inrush current I_{starting} . This inrush current can be between three and fifteen times as high as the rated operational current, depending on the type of motor. A figure between seven and eight times the rated operational current can be postulated as typical.

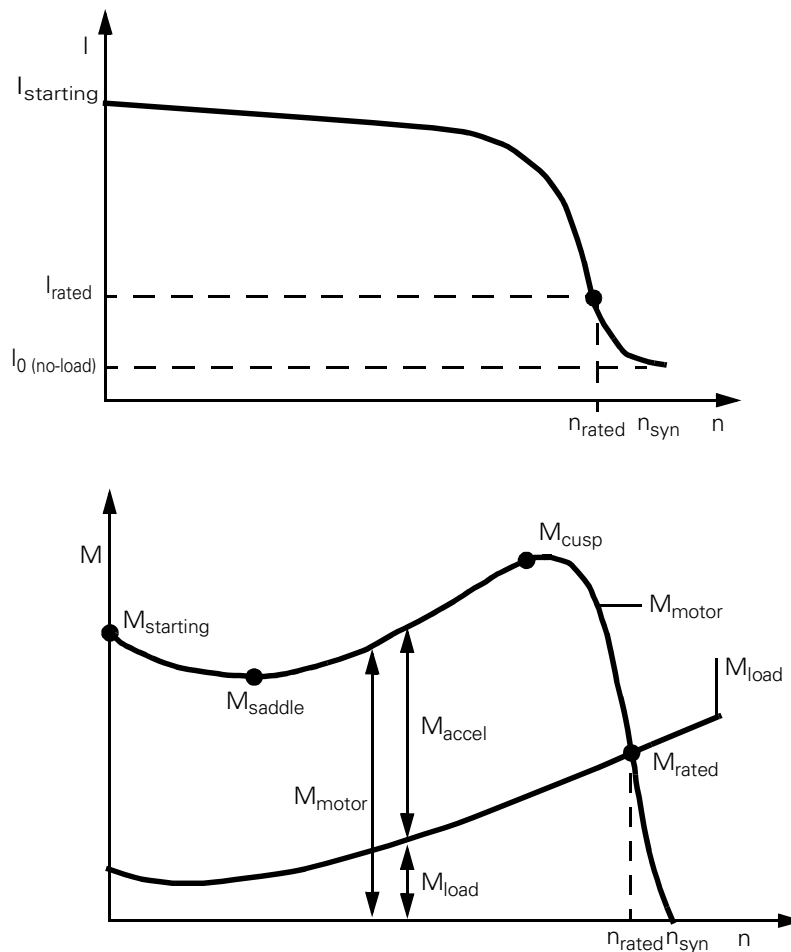

Fig. 8-2: Typical current and torque curve of a three-phase asynchronous motor

Important

This starting current must be taken into consideration in the design of the supply network, among other things by adapting the supply (high heat development) and the fusing (inadvertent tripping of the fuses).

Reducing the starting current

There are various ways of reducing the starting current:

- By star-delta starter
- By frequency converter
- By soft starter

Star-delta starter

After a delay, the motor windings are switched from a star to a delta configuration. The motor current for star starting is only about 1/3 of that required for delta starting (motor torque, too, is reduced to approximately 1/3 of the delta torque).

Disadvantages:

- 6 motor cables are necessary
- Switching surges occur (in the current and torque transients)
- The startup cannot be adapted to the system environment
- Installation is relatively complicated and time-consuming
- More space is needed in the cubicle

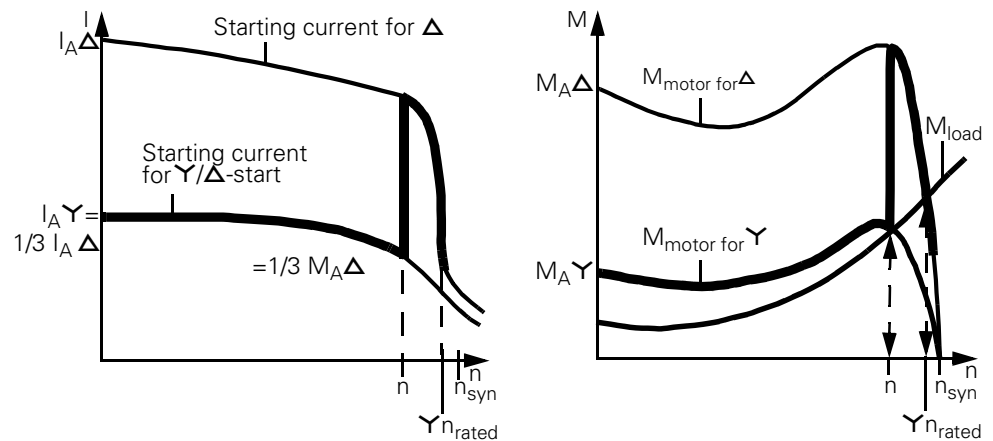

Fig. 8-3: Current and torque curves for star-delta starting

Frequency converter

A frequency converter converts the AC voltage from the grid to direct voltage, which can then be converted to any voltage and frequency. The illustration below shows how a frequency converter works:

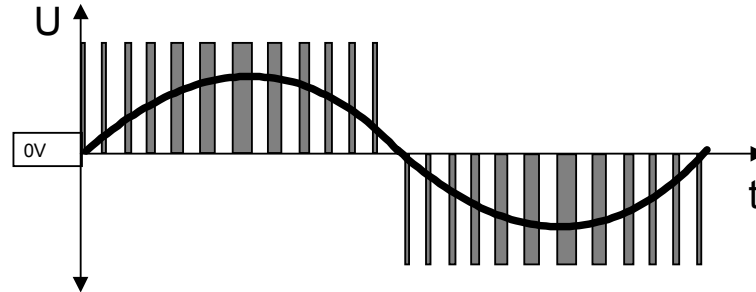

Fig. 8-4: Method of operation of a frequency converter

Disadvantages:

- Relatively complicated wiring needed in order to meet radio interference suppression requirements; filters are often essential.
- Line capacitances limit the lengths of motor feeder cables; it may be necessary to use chokes, sinus filters, or even dV/dt filters.
- Expensive
- System startup is complex and time-consuming on account of the multiplicity of operating parameters.
- It can be necessary to use shielded motor feeder cables.

Advantages:

- Motor speed is variable; speed can be accurately pegged at constant levels.

The U/f ratio remains virtually constant. It is therefore possible to achieve high torques at relatively low currents.

Soft starter

With a soft starter, motor voltage is increased from a selectable starting voltage to the rated voltage by phase firing within a defined starting time. Motor current is proportional to the motor voltage, so the starting current is reduced by the factor of the defined starting voltage.

The illustration below shows how the 3RW3 soft starter works:

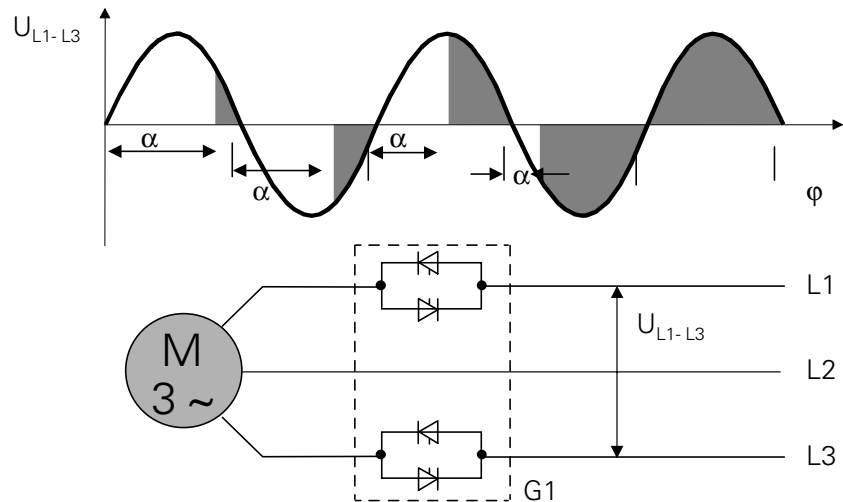

Fig. 8-5: Phase firing of the supply voltage by semiconductor elements in the 3RW3 soft starter

Example:

Starting voltage 50 % of U_e => starting current equals 50 % of the motor starting current for direct-on-line starting.

A soft starter also reduces motor torque. This is the reason why a soft-started motor does not jerk into action.

The relationship is as follows: The motor torque is proportional to the square of the motor voltage.

Example:

Starting voltage 50 % of U_e => starting torque 25 % of the starting torque for direct-on-line starting.

Advantages:

- Less space needed in the cubicle
- No protective circuits (e.g. filters) necessary to comply with the radio interference suppression specifications (class A; in UC 24 V control voltage version also class B)
- Lower installation costs
- Straightforward system startup
- Only 3 motor feeder cables, half as many as are needed for a star-delta starter
- Adjustment options permit adaptation to the system.

Disadvantages:

- Long-term speed settings not possible.
- Lower torque at reduced voltage

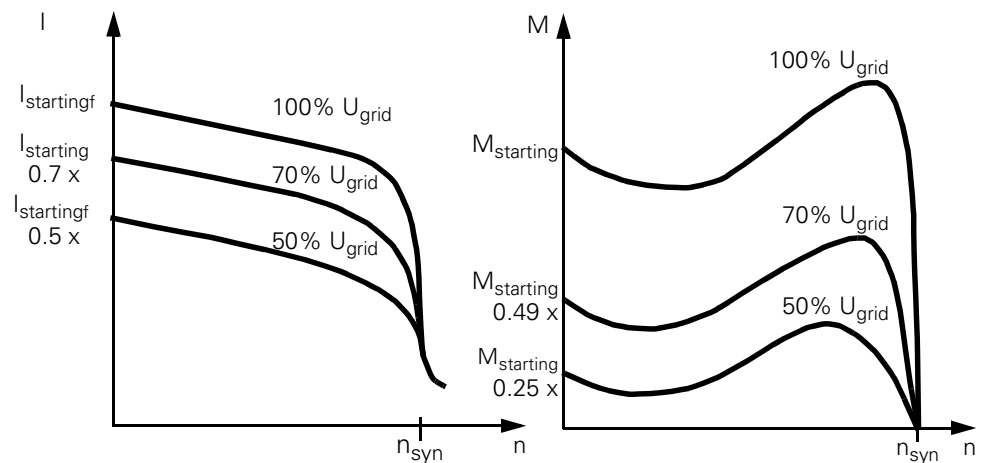

Fig. 8-6: Current and torque curves for a soft starter

8.2.2 General device description

The SIRIUS modular system offers a variety of alternatives for load feeders. In addition to the star-delta starters (see Chapter 5, "3RA fuseless load feeders"), the SIRIUS 3RW3 soft starters are also available.

The 3RW3 soft starters can be combined with the following SIRIUS devices:

- 3RT contactors
- 3RV circuit breakers
- 3RU thermal overload relays
- 3RB10 electronic overload relays

They are all mounted and connected up in the same way.

Please note the relevant guidelines in Section 8.3.2.

Functions of the load feeder

Normal switching duty

Normal switching duty of a circuit can, according to the definitions of isolation and normal switching data in DIN VDE 0100 (see Section 8.1), be implemented with a contactor or a soft starter alone.

Isolation

According to DIN VDE 0100, isolation from the supplying network cannot be provided by a semiconductor element (i.e. soft starter, frequency converter, contactor, or similar).

To implement isolation from the supplying network, a 3RV circuit breaker (or another isolating device that fulfills the requirements of DIN VDE 0100) must be used in addition to the contactor or soft starter. A contactor alone in combination with the soft starter is not enough.

Both isolation and normal switching duty can be implemented quickly and easily with the 3RW3 soft starter in combination with the modules from the SIRIUS modular system.

Variants

The electronic soft starters are available in two variants:

Standard 3RW30 variant

The standard 3RW30 variant is used for single-speed motors. This variant is available in all four frame sizes. The starting voltage U_s , starting time $t_{R\text{on}}$, and coasting-down time $t_{R\text{off}}$ can be set independently of each other on the device. The device is switched on by means of a cycling contact IN.

3RW31 special variant

The 3RW31 special variant cycles pole-changing motors (Dahlander winding). The following can be set independently of each other:

- Starting voltage U_s
- Starting time of initial speed t_{R1}
- Starting time of second speed t_{R2}

The device does not have a coasting-down function. The set starting voltage applies to both ramp times t_{R1} and t_{R2} .

The ramp time is selected by means of two inputs, IN1 and IN2, that switch the soft starter on.

The devices of the 3RW31 series are only available in frame size S0.

Settings

The devices can be set as follows:

3RW30

By means of 3 potentiometers for setting:

- Starting time in the range from 0 to 20 seconds
- Starting voltage in the range from approx. 30 to 100 % of the rated voltage of the motor
- Coasting-down time in the range from 0 to 20 seconds

3RW31

By means of 3 potentiometers for setting:

- Starting time 1 in the range from 0 to 20 seconds
- Starting voltage in the range from approx. 30 to 100 % of the rated voltage of the motor
- Starting time 2 in the range from 0 to 20 seconds

A special software program ensures that progressive ramp times are set.

Short times of up to 5 seconds can thus be set very precisely.

Auxiliary contacts

3RW30

In the case of frame sizes S0 to S3, the following auxiliary contacts are integrated:

- "ON": When triggered, the latching signal is used for locking by means of a simple on/off pushbutton (contact designation 13/14).
- "BYPASSED": With the end-of-startup signal, control valves can be addressed after soft starting of a pump, for example, in order to enable pumping (contact designation 23/24).

The devices of frame size S00 do not have any auxiliary switches.

3RW31

The 3RW31 does not have any auxiliary contacts.

Soft starting function

Torque-reduced start for three-phase asynchronous motors: Triggering is two-phase, which means that the current is kept low throughout the run-up phase. Current peaks such as those that occur in a star-delta start at the changeover from star to delta are prevented by continuous voltage management. Transient current peaks (inrush peaks) are automatically avoided in each switch-on procedure by a special control function of the power semiconductors.

Soft coasting-down function

The integrated soft coasting-down function prevents the drive coming to an abrupt halt when the motor is switched off.

3RW30 time ramps

The following graphics show the time ramp of the 3RW30 and the timing diagram of the auxiliary contacts:

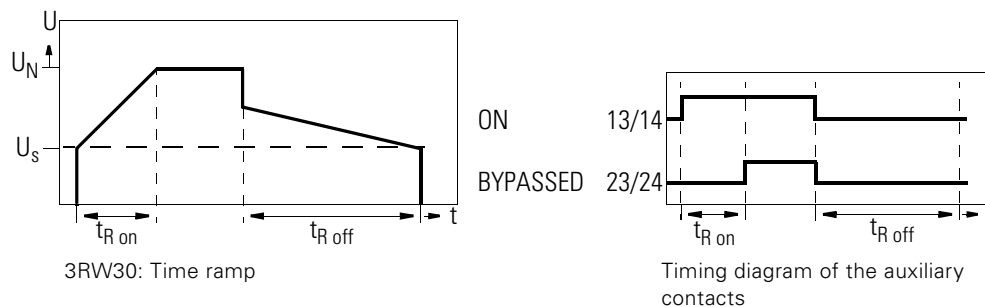

Fig. 8-7: Time ramp/timing diagram, 3RW30

The graphic below shows the time ramp of the 3RW31:

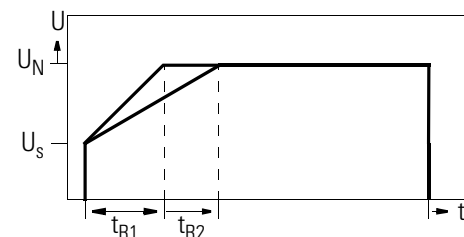

Fig. 8-8: Time ramp, 3RW31

Accessories

A fan can be snapped into the soft starter housing of frame sizes S0 to S3 from below. This brings the following benefits:

- Improved range of options for the installation position
- Increase in the switching frequency (see Section 8.3.2, "Installation guidelines")

In the case of frame sizes S0 and S2, extended terminal covers can be mounted on the box covers in order to cover the cable ends and keep them safe from fingers. These are identical to the extended terminal covers of the SIRIUS 3RT contactors of the same frame sizes.

In the case of frame size S3, terminal covers are available for lug connection or bar connection. These, too, are identical to the accessory parts of the corresponding SIRIUS contactor size.

See Section 8.4 for details of other accessories.

Mounting

The devices are attached to the 3RV circuit breakers by means of a link module and are thus connected mechanically and electrically. This link module is identical to the one that is used for the corresponding contactor/circuit-breaker combinations. This installation variant offers all the advantages of a fuseless load feeder.

Link modules

The following link modules are used to combine 3RW3 soft starters and 3RV1 circuit breakers:

Frame size	Link module
S00	3RA1911-1A
S0	3RA1921-1A
S2	3RA1931-1A
S3	3RA1941-1A

Table 8-3: Link modules

Connection

The 3RW3 electronic soft starters are available with screw-type terminals. Plus-minus POZIDRIV 2 screws are used.

The SIGUT terminal system is used (captive screws, contacts open on delivery, etc.).

8.2.3 Comparison of the 3RW3 semiconductor motor control unit (soft starter) with the SIKOSTART 3RW22 and SIKOSTART 3RW34 motor control units

Soft starters are available for different applications.
The following graphic provides an overview of the different soft starters:

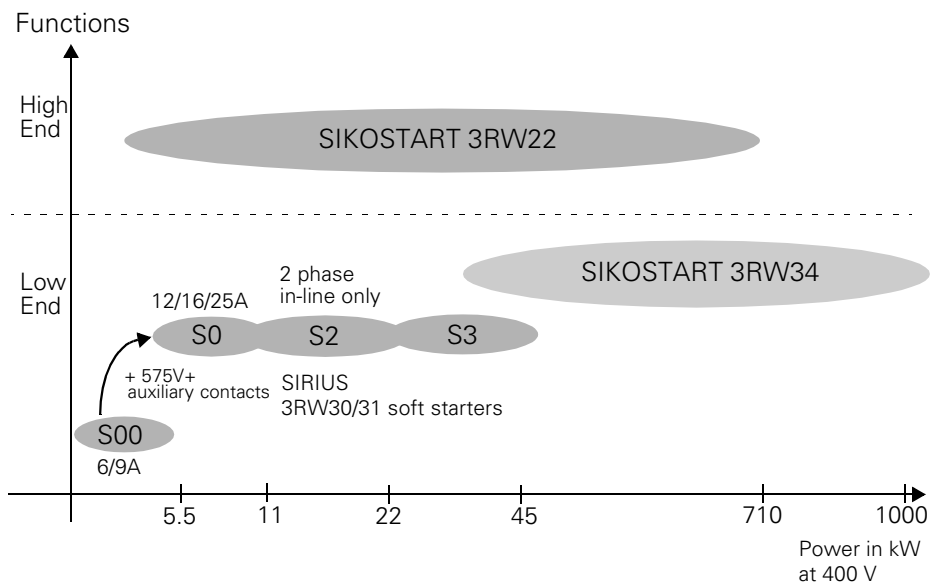

Fig. 8-9: Overview of soft starters

SIKOSTART 3RW22

The SIKOSTART 3RW22 is suitable for drives that place high demands on the functionality of the starter. It covers a power range from 3 kW to 710 kW (at 400 V).

SIKOSTART 3RW22 offers the following:

- Soft starting and soft coasting down
- Break-loose torque
- DC brakes
- Energy-saving operation
- Temperature monitoring
- Operation using a PC and an RS232 interface
- Selection and configuration program
- Current and voltage limitation
- Pump functionalities (e.g. pump coasting down)
- Startup detection
- Three parameter sets
- Different coasting-down types
- Electronic device overload protection

The SIKOSTART 3RW22 application manual presents the various application areas and circuit variants (order no. E20001-P285-A484-V3).

SIKOSTART 3RW34

The SIKOSTART 3RW34 is suitable for drives with low demands in terms of the functionality of the soft starter. The SIKOSTART 3RW34 is very similar to the SIRIUS 3RW3 soft starter in terms of its operation and configuration. It covers a power range of up to 1000 kW (400 V).

The functions of the 3RW34 are as follows:

- Soft starting and soft coasting down
- 2 circuit variants: standard and root 3 circuits
- Three-phase control
- Optional AS-Interface bus control

You will find the technical specifications and a detailed description of the 3RW34 in the document describing SIKOSTART 3RW22/3RW34 solid-state motor controllers (order no.: E20001-A200-P302).

SIRIUS 3RW3 soft starter

The SIRIUS 3RW3 soft starter covers the power range from 1.5 kW to 45 kW.

Power semiconductors always exhibit power loss. This manifests itself in heat generation. In order to keep this power loss as low as possible, the semiconductors are bypassed by relay contacts after the motor has started up. The device's heat sink and its dimensions can thus be smaller than they otherwise would be. In addition, it is necessary to use a bypass contactor, which bypasses the line semiconductors in the conventional configuration. For further processing in the system controller, the device offers two relay outputs:

- "ON" contact (terminals 13/14), which can be used, for example, to control the soft starter by button (locking)
- "BYPASSED" contact (terminals 23/24), which signals the completion of startup (e.g. in order to switch a solenoid valve after a soft-started pump has started up)

For drives in this power range, good motor startups can be achieved with a two-phase controller.

In the case of a two-phase controller, semiconductor elements are only used in two phases in order to reduce motor current and motor voltage in all three phases. The third phase is bypassed internally in the soft starter.

8.2.4 Comparison of the 3RW3 semiconductor motor control unit (soft starter) with the 3RA star-delta combination

The comparison of soft starter and star-delta combinations shows that the 3RW3 has the following advantages (example here 22 kW):

3RW3 soft starter	3RA star-delta starter
Width: 55 mm	Width: 165 mm
Wiring: 3 motor supply leads	Wiring: 6 motor supply leads
Selectable startup parameters	None
Minimum current values at startup	Fixed current ratios ($I_{\gamma} = 1/3 I_{\Delta}$)
No dangerous switchover current peaks	Switchover current peaks when switching from star to delta
Special variant for Dahlander motors	—
Soft coasting-down function	—

Table 8-4: Comparison of 3RW3/3RA

8.2.5 Notes on configuration

In order for a motor to reach its rated speed, motor torque at any given time during startup must be greater than the torque needed by the load, since otherwise a stable operating point would be reached before the motor achieved its rated speed (the motor would "drag to a stop"). The difference between motor torque and load torque is the accelerating torque that is responsible for the increase in the speed of the drive. The lower the accelerating torque, the longer the motor needs to run up to its operating speed.

Starting torque

Reducing the terminal voltage of a three-phase asynchronous motor reduces the motor's starting current and the starting torque. Current is directly proportional to voltage, whereas voltage is proportional to the square root of motor torque.

Example:

Motor = 55 kW, rated current = 100 A, starting current = 7 x rating current, motor torque = 355 Nm, starting torque = 2.4 x rated torque
Settings for the soft starter: starting voltage 50 % of rated voltage for motor
The reductions are thus as follows:

- The starting current is reduced to half the starting current for a direct start: 50 % of (7 x 100 A) = 350 A
- Starting torque is reduced to $0.5 \times 0.5 = 25$ % of the starting torque for a direct start: 25 % of 2.4×355 Nm = 213 Nm

Note

On account of the fact that the starting voltage is proportional to the square root of the motor torque, it is important to ensure that the starting voltage is not too low. This applies particularly for a pronounced saddle torque, the lowest motor torque that occurs during run-up to rated speed.

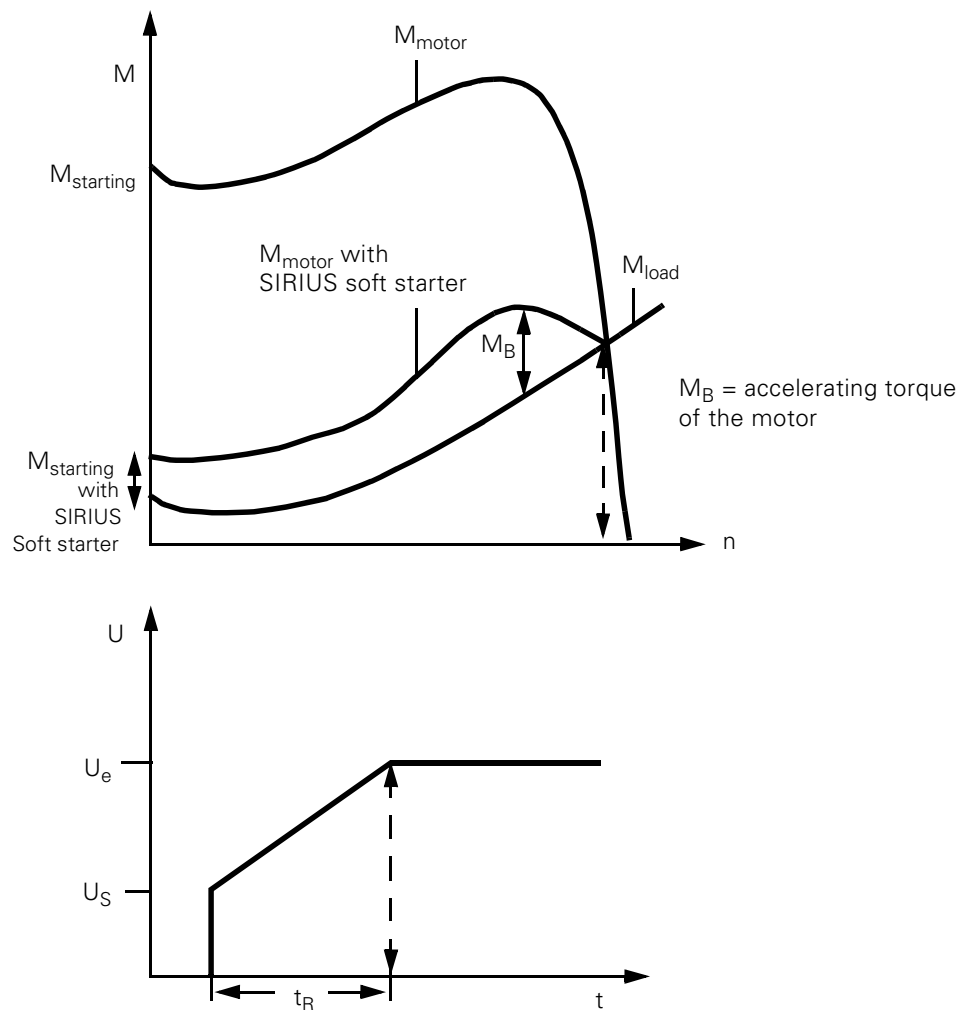

Fig. 8-10: Load and motor torques and motor terminal voltage for operation with soft starter

Criteria for selection**Note**

In the case of the SIRIUS 3RW30/31 soft starters, the corresponding soft starter must be selected on the basis of the rated current for the motor (the rated current of the soft starter must be \geq the rated current for the motor).

The 3 potentiometers on the starter are for setting the starting voltage, the starting time, and the coasting-down time.

The soft starter is correctly set when the motor starts smoothly and runs up rapidly to its rated speed.

Ramp times of up to 20 seconds can be set.

8.3 Application and use

8.3.1 Areas of application and criteria for selection

The SIRIUS 3RW3 soft starters offer an alternative to star-delta starters (see Section 8.2.4 for a comparison and the advantages).

The most important advantages are soft starting and soft coasting-down, interruption-free switching without current spikes that could interfere with the supply system, and compact dimensions.

Many drives that needed frequency converters in the past can be changed to soft-start operation with the 3RW3, if the applications do not call for variations in speed.

Applications

Typical applications include, for example:

Conveyor belts, conveyor systems:

- Smooth starting
- Smooth slowing
- Use of better-value conveyor material

Rotary pumps, piston-type pumps

- Avoidance of pressure surges
- Extended service life of the piping system

Agitators, mixers:

- Reduced starting current

Fans:

- Less strain on gearing and drive belts

Cooling time

Note

The cooling time must be taken into consideration in the starting frequency.

8.3.2 Installation guidelines

On account of the heat generated, certain installation guidelines must be adhered to when combining 3RW30/31 soft starters with other SIRIUS switching devices.

Stand-alone installation

Stand-alone installation is when minimum vertical **and** lateral clearances between the mounted devices are not violated. This applies both to individual devices and complete load feeders.

The following minimum clearances must be adhered to in stand-alone installation (these minimum clearances depend on the frame size):

Frame size	Minimum clearance on both sides in mm
S00	15
S0	20
S2	30
S3	40

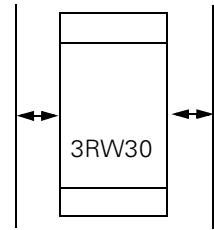

Table 8-5: Stand-alone installation, minimum clearances at the side, 3RW3

Frame size	Vertical clearance a	Vertical clearance b
S00	50	50
S0	60	40
S2	50	30
S3	60	30

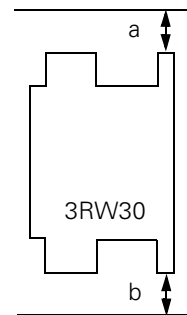

Table 8-6: Stand-alone installation, minimum clearances at the side, 3RW3

Line lengths for the drive circuit

The control inputs for starting and stopping are not rated for longer distances. This means:

- In the case of a drive circuit that goes beyond the control cubicle, coupling relays must be used.
- The control cables in the cubicle should not be laid together with main circuit cables.

When electronic output modules are used in the drive circuit (e.g. Triac outputs at 230 VAC), RC elements (e.g. 3TX7462-3T or similar with $C > 100$ nF) may be required at the control inputs under certain circumstances.

Correction factors

If the minimum clearances are violated, in a combination of a soft starter with a circuit breaker, fixed correction factors must be used to determine the rated current for the device and the switching frequency.

The following variables can be modified by means of correction factors:

- Rated current for the device
- Switching frequency
- Current setting of the circuit breaker
- Current setting of the overload relay

Correction factor for the rated current of the device

A factor is specified by which the device rated current of the soft starter is reduced.

Example:

Correction factor for the rated current of the device = 0.9

Selected device = 3RW3014-1CB14 (under normal conditions at 40 °C a device rated current of 6 A)

This results in an actual device rated current of:

$$0.9 \times 6 \text{ A} = 5.4 \text{ A}$$

Correction factor for switching frequency

The switching frequency is the maximum permissible number of starts per hour. This value must be adjusted by the specified correction factor. The number of permissible starts per hour is given in Table 8.7.1, Control electronics/power electronics, in Section 8.7, Technical specifications.

The specified correction factors refer to the following operating conditions: S4 operation, 40 °C ambient temperature, 30 % duty cycle

Example:

Correction factor for the switching frequency = 1.5

Selected device = 3RW3014-1CB14 (has a maximum switching frequency of 30 starts per hour under the conditions specified above)

This results in a corrected switching frequency of:

$$1.5 \times 30 = 45 \text{ starts per hour}$$

To increase the switching frequency, it is also possible to use a larger device.

Correction factor for the current setting of the circuit breaker

In combinations of a 3RW30 soft starter and a 3RV1 circuit breaker, the set value of the circuit breaker may have to be corrected appropriately. The correction factor specifies the extent of the change.

Example:

Correction for the current setting of the circuit breaker: 1.1

Selected device = 3RW3014-1CB14

The connected motor has a motor rated current of 5 A.

The set value of the circuit breaker must be changed to:

$$1.1 \times 5 \text{ A} = 5.5 \text{ A}$$

Correction factor for the current setting of the overload relay

In combinations of a 3RW30 soft starter + 3RU1 thermal overload relay or 3RW30 software starter + 3RB10 electronic overload relay, the set value of the overload relay must be corrected appropriately. The correction factor specifies the extent of the change.

Example:

Correction factor for the current setting of the overload relay 0.9

Selected device = 3RW3014-1CB14

The connected motor has a motor rated current of 5 A.

The set value of the overload relay now has to be changed to:

$$0.9 \times 5 \text{ A} = 4.5 \text{ A}$$

8.3.3 Overview tables: correction factors

The tables below give the correction factors for the circuit-breaker current setting, the device rated current, and the switching frequency.

The values indicate the difference between use with a fan (accessory) and use without a fan.

All correction fans apply throughout the entire temperature range (i.e. for 40 °C, 50 °C, and 60 °C).

The various tables specify the values in turn for the following:

3RW30/31 soft starters in a stand-alone installation

3RW30/31 soft starter + 3RV1 circuit breaker

3RW30/31 soft starter + 3RT1 contactor + 3RU1 thermal overload relay

3RW30/31 soft starter + 3RT1 contactor + 3RB10 electronic overload relay

8.3.3.1 3RW30/31 soft starters in a stand-alone installation**Minimum clearance**

In the case of frame size S00 (3RW301..), the following applies to stand-alone, vertical installation without directly attached switching devices:

In order to maintain the required space above the arc chute, clearance of at least 50 mm must be maintained to grounded parts above and below.

3RW30/31 correction factors

3RW30/31 soft starters not combined with any other switching devices:

			Without fan				With fan	
			Stand-alone installation		Installed side by side		Stand-alone installation or side by side	
			Correction factor		Correction factor		Correction factor	
Order number	Frame size	Device rated current in A at 40 °C	Rated current for the device	Switching frequency	Rated current for the device	Switching frequency	Rated current for the device	Switching frequency
3RW3014-1CB..	S00	6	1	1	1	0.75	- 1)	- 1)
3RW3016-1CB..	S00	9	1	1	1	0.75	- 1)	- 1)
3RW3.24-1AB..	S0	12.5	1	1	1	0.65	1	1.8
3RW3.25-1AB..	S0	16	1	1	1	0.65	1	1.8
3RW3.26-1AB..	S0	25	1	1	1	0.65	1	1.8
3RW3034-1AB..	S2	32	1	1	1	0.65	1	1.8
3RW3035-1AB..	S2	38	1	1	1	0.65	1	1.8
3RW3036-1AB..	S2	45	1	1	1	0.65	1	1.8
3RW3044-1AB..	S3	63	1	1	1	0.8	1	1.6
3RW3045-1AB..	S3	75	1	1	1	0.75	1	1.6
3RW3046-1AB..	S3	100	1	1	1	0.7	1	1.6

Table 8-7: Correction factors, 3RW30/31

- 1) The SIRIUS 3RW301.. soft starters cannot be operated with a fan.

8.3.3.2 3RW30/31 soft starters in combination with the 3RV1 circuit breaker

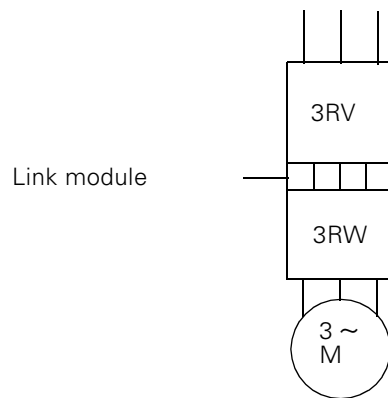

Fig. 8-11: 3RW3 soft starter + 3RV1 circuit breaker

Dimensioning of the circuit breaker

The frame size selected for the circuit breaker should be large enough so that the current value calculated can just be set. In the event of current values that are lower than can be set for the specified circuit breaker, the next smaller circuit breaker must be used.

**Correction factors:
3RV1 + 3RW30/31**

Combination of a 3RV1 circuit breaker + 3RW30/31 soft starter:

Order number	Frame size	Device rated current in A at an ambient temperature of 40 °C	Order number Circuit breaker	Adjustment range Circuit breaker	Without fan			With fan		
					Stand-alone installation	Installed side by side	With fan Installed side by side	Stand-alone installation	Installed side by side	With fan Installed side by side
3RW3014-1CB.. 3RW3016-1CB..	S00 S00	6 9	3RV1011-1GA10 3RV1011-1JA10	(4.5 - 6.3) A (7 - 10) A	1	1	1	1	1	1
					0.9	0.5	0.5	1	1	1
3RW3.24-1AB.. 3RW3.25-1AB..	S0 S0	12. 16	3RV1021-1KA10 3RV1021-4AA10	(9 - 12) A (11 - 16) A	1	1	1	1	1	1
					0.5	0.5	0.5	1	1	1
3RW3.26-1AB.. 3RW3034-1AB..	S0 S2	25 32	3RV1021-4DA10 3RV1031-4EA10	(20 - 25) A (22 - 32) A	1	0.75	0.9	1	1	1
					0.75	0.5	0.95	1	1	1
3RW3035-1AB.. 3RW3036-1AB..	S2 S2	38 45	3RV1031-4FA10 3RV1031-4GA10	(28 - 40) A (36 - 45) A	1	0.85	0.9	1	1	1
					0.85	0.4	0.95	1	1	1
3RW3044-1AB.. 3RW3045-1AB..	S3 S3	63 75	3RV1041-4JA10 3RV1041-4KA10	(45 - 63) A (57 - 75) A	1	0.85	0.95	1	1	1
					0.85	0.6	1	1	1	1
3RW3046-1AB.. 3RW3046-1AB..	S3 S3	100	3RV1041-4MA10 3RV1041-4MA10	(80 - 100) A (80 - 100) A	1	0.75	0.85	1	1	1
					0.75	0.55	1	1	1	1

1) = SIRIUS 3RW301 .. soft starters cannot be used with a fan

Table 8-8: Correction factors: 3RV1 circuit breaker + 3RW3 soft starter

8.3.3.3 Combining the 3RT contactor with the 3RU1 thermal overload relay and 3RW3 soft starter

Frame size of the overload relay

The frame size selected for the overload relay should be large enough so that it is just possible to set the current value calculated. In the event of current values that are lower than can be set for the specified overload relay, the next smaller overload relay must be used.

Important

It is not permissible to mount the thermal overload relay under the contactor/connecting lead/soft starter combination. The overload relay must be integrated in the feeder before the contractor/connecting lead/soft starter combination. The specified correction factors apply only to this permissible mounting sequence.

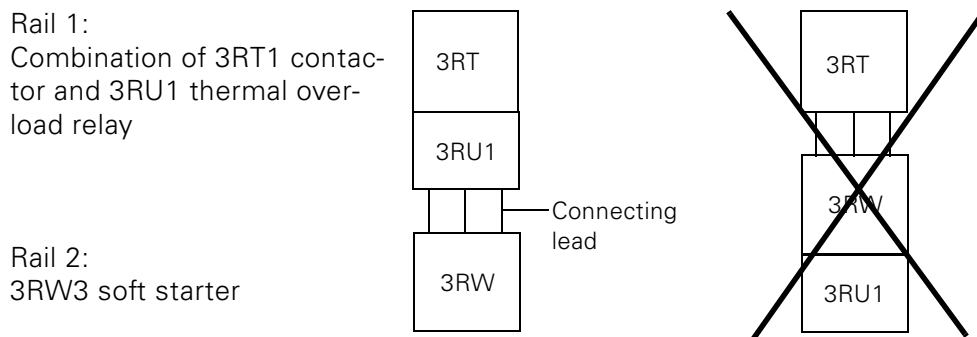

Fig. 8-12: 3RT+3RU1+3RW3 combination

Minimum clearance

For thermal reasons, a minimum clearance is necessary between the contactor/overload relay combination and the soft starter, as is a minimum length of the connecting leads. The following table specifies the minimum clearances and minimum lengths of the connecting leads for the various frame sizes:

Frame size	Minimum clearance between rail 1 and rail 2 (center to center) in mm	Minimum length of the connecting lead in mm
S00	160	100
S0	200	150
S2	240	200
S3	300	250

Table 8-9: 3RW3 installation guidelines, minimum clearances/lengths

Correction factors: 3RT + 3RU1 + 3RW30/31

Combination of the 3RT1 contactor with an attached 3RU1 thermal overload relay/connecting lead/3RW30/31 soft starter:

Order number	Frame size	Device rated current in A at an ambient temperature of 40 °C	Contactor order number	Order number Therm. overload relay	Setting range of the overload relay	Without fan Stand-alone installation			Without fan Installed side by side			With fan Stand-alone installation			With fan Installed side by side			
						Correction factor Rated current for the device	Correction factor for switching frequency	Correction factor Set value for th. overload relay	Correction factor Rated current for the device	Correction factor for switching frequency	Correction factor Set value for th. overload relay	Correction factor Rated current for the device	Correction factor for switching frequency	Correction factor Set value for th. overload relay	Correction factor Rated current for the device	Correction factor for switching frequency	Correction factor Set value for th. overload relay	
3RW3014-1CB..	S00	6	3RT1015-1A..	3RU1116-1GBO	(4.5 - 6.3) A	0.95	1	1	0.9	0.75	1	1	1	1	1	1	1	1
3RW3016-1CB..	S00	9	3RT1016-1A..	3RU1116-1JBO	(7 - 10) A	0.9	0.95	1	0.8	0.8	1	1	1	1	1	1	1	1
3RW3.24-1AB..	S0	12.5	3RT1024-1A..	3RU1126-1KBO	(9-12.5)A	0.95	0.9	1	0.9	0.55	1	1	1	1	1	1	1	1
3RW3.25-1AB..	S0	16	3RT1025-1A..	3RU1126-4ABO	(11-16)A	0.95	0.9	1	0.9	0.55	1	1	1	1	1	1	1	1
3RW3.26-1AB..	S0	25	3RT1026-1A..	3RU1126-4DBO	(22-25)A	0.9	0.8	1	0.8	0.55	1	1	1	1	1	1	1	1
3RW3034-1AB..	S2	32	3RT1034-1A..	3RU1136-4EBO	(22-32)A	0.95	0.7	1	0.9	0.45	1	1	1	1	1	1	1	1
3RW3035-1AB..	S2	38	3RT1035-1A..	3RU1136-4FBO	(28-40)A	0.95	0.9	1	0.9	0.35	1	1	1	1	1	1	1	1
3RW3036-1AB..	S2	45	3RT1036-1A..	3RU1136-4HBO	(36-45)A	0.9	0.95	1	0.8	0.45	1	1	1	1	1	1	1	1
3RW3044-1AB..	S3	63	3RT1044-1A..	3RU1146-4JBO	(45-63) A	0.95	0.9	1	0.9	0.65	1	1	1	1	1	1	1	1
3RW3045-1AB..	S3	75	3RT1045-1A..	3RU1146-4KBO	(57-75) A	0.95	0.85	1	0.9	0.5	1	1	1	1	1	1	1	1
3RW3046-1AB..	S3	100	3RT1046-1A..	3RU1146-1MBO	(80-100) A	0.9	0.8	1	0.8	0.55	1	1	1	1	1	1	1	1

1) = SIRIUS 3RW301 .. soft starters cannot be used with a fan.

Table 8-10: Correction factors, 3RT contactor + 3RU therm. overload relay + 3RW soft starter

8.3.3.4 Combining the 3RT contactor with the 3RB10 electronic overload relay and 3RW3 soft starter

The contactor, electronic overload relay, and soft starter can be connected in two ways:

- Combining a 3RT1 contactor with an attached 3 RB10 electronic overload relay, a connecting lead, and a 3RW30/31 soft starter
- Combining a 3RT1 contactor with a connecting lead and a combination of a 3RW30/01 soft starter with an attached 3RB10 electronic overload relay

3RT + 3RB10 + connecting lead + 3RW3

Rail 1:
Combination of a 3RT1 contactor and a 3RB10 electronic overload relay

Rail 2:
3RW30/31 soft starter

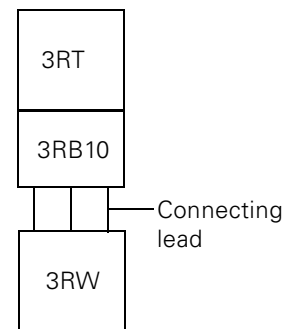

Fig. 8-13: 3RT+3RB10+3RW3 combination

Minimum clearance

For thermal reasons, a minimum clearance is necessary between the contactor/overload relay combination and the soft starter, as is a minimum length of the connecting leads.

The following table specifies the minimum clearances and minimum lengths of the connecting leads for the various frame sizes:

Frame size	Minimum clearance between rail 1 and rail 2 (center to center) in mm	Minimum length of the connecting lead in mm
S00	160	100
S0	200	150
S2	240	200
S3	300	250

Table 8-11: 3RT + 3RB10 + 3RW3 installation guidelines, minimum clearances/minimum lengths

**3RT + connecting lead +
3RB10 + 3RW3**

Rail 1:
3RT1 contactor

Rail 2:
Combination of 3RW30/31 soft
starter and 3RB10 electronic
overload relay

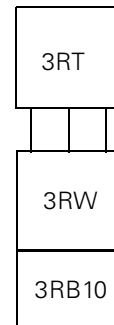

Fig. 8-14: 3RT+3RW3+3RB10 combination

Minimum clearances

Frame size	Minimum clearance between rail 1 and rail 2 (center to center) in mm	Minimum length of the connecting lead in mm
S00	100	100
S0	140	150
S2	180	200
S3	240	250

Table 8-12: 3RT1 + 3RW30/31 + 3RB10 installation guidelines, minimum clearances/minimum lengths

Correction factors: 3RT + 3RB10 + 3RW3

Combining a 3RT1 contactor with an attached 3RB10 electronic overload relay, a connecting lead, and a 3RW30/31 soft starter

Order number	Frame size	Device rated current in A at an ambient temperature of 40 °C	Contactor order number	Order number of electronic overload relay	Setting range of the overload relay	Without fan			With fan		
						Stand-alone installation	Installed side by side	With fan Stand-alone installation	Installed side by side	With fan Stand-alone installation	Installed side by side
3RW3014-1CB..	S00	6	3RT1015-1A..	3RB1016-1SBO	(3-12)/A	1	1	1	1	1	1
3RW3016-1CB..	S00	9	3RT1016-1A..	3RB1016-1SBO	(3-12)/A	1	1	1	1	1	1
3RW3.24-1AB..	S0	12.5	3RT1024-1A..	3RB1026-1OBO	(6-25)/A	1	1	1	1	1	1
3RW3.25-1AB..	S0	16	3RT1025-1A..	3RB1026-1OBO	(6-25)/A	1	1	1	1	1	1
3RW3.26-1AB..	S0	25	3RT1026-1A..	3RB1026-1OBO	(6-25)/A	1	1	1	1	1	1
3RW3034-1AB..	S2	32	3RT1034-1A..	3RB1036-1UBO	(15-50)/A	1	1	1	1	1	1
3RW3035-1AB..	S2	38	3RT1035-1A..	3RB1036-1UBO	(15-50)/A	1	1	1	1	1	1
3RW3036-1AB..	S2	45	3RT1036-1A..	3RB1036-1UBO	(15-50)/A	1	1	1	1	1	1
3RW3044-1AB..	S3	63	3RT1044-1A..	3RB1046-1EBO	(25-100)/A	1	1	1	1	1	1
3RW3045-1AB..	S3	75	3RT1045-1A..	3RB1046-1EBO	(25-100)/A	1	1	1	1	1	1
3RW3046-1AB..	S3	100	3RT1046-1A..	3RB1046-1EBO	(25-100)/A	1	1	1	1	1	1

1) = SIRIUS 3RW301 .. soft starters cannot be used with a fan.

Table 8-13: Correction factors, 3RT contactor + 3RB10 electronic overload relay + 3RW soft starter

8.3.4 Circuit example

Circuit example with 3RW30 frame size S0, S2, S3 (variant with UC110-230 V):

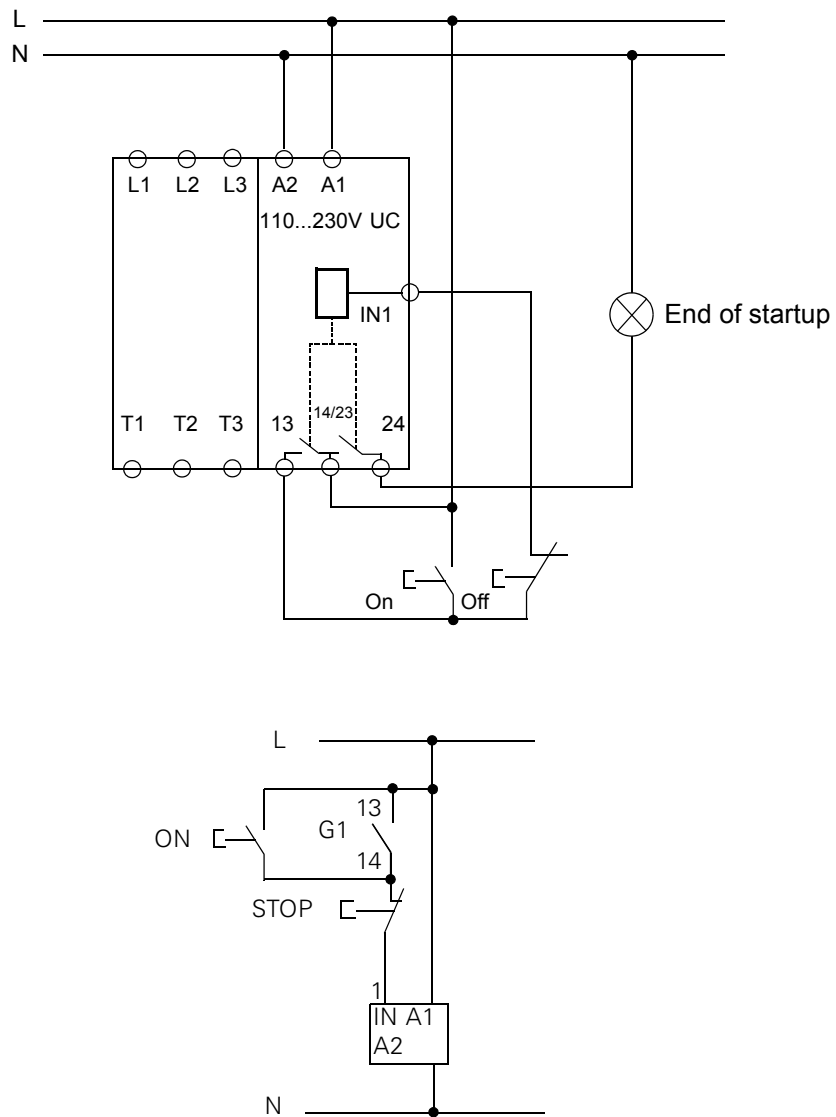

Fig. 8-15: Circuit example, 3RW3

8.3.5 Commissioning

Every SIRIUS 3RW soft starter comes with the following warning, which it is imperative to heed:



Caution

This device has been tested carefully at the factory and found to be in working order.

During transportation, however, it may have been subject to stresses over which we have no control. The bypass relays in the main circuit may be in an undefined state.

In the interests of complete safety, the following procedure should be used at commissioning or after the replacement of the SIRIUS soft starter:

First, apply the supply voltage to A1/A2 in order to put the impulse series relays in a defined switching state.

Then, switch on the main circuit (L1/L2/L3).

If you do not do this, the motor can be switched on inadvertently and cause damage to people or parts of the system.

Settings

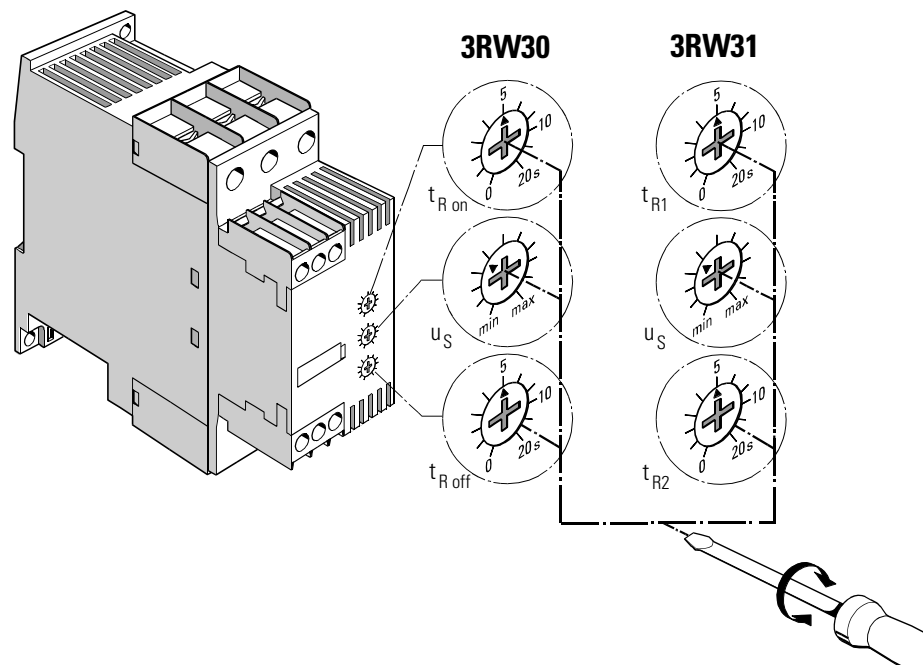

Fig. 8-16: Settings, 3RW3

Note

At commissioning, the settings of the potentiometers for the ramp time and the starting voltage should remain unchanged. These set values must be obtained in a trial.

Changing settings	<p>The potentiometer settings are scanned before each switching operation ("ON" or "OFF").</p> <p>If, for example, the setting of the potentiometer for starting time is changed while the motor is running up, the change does not come into effect until the next start.</p>
Starting voltage	<p>The starting voltage should be set to a value at which the motor starts rapidly.</p>
Ramp time	<p>The ramp time should be set such that the motor can run up within the time defined in this way.</p> <p>If the star time for star-delta starting is known, the ramp time can be set to this value.</p>
Coasting-down time	<p>The potentiometer for the coasting-down time is for setting the duration of the voltage ramp for coasting down. This parameter can be used to make the motor run-down longer than it would be if the motor were merely to coast to a stop.</p> <p>The motor coasts to a stop on its own if this potentiometer is set to a value of 0.</p>
Switching frequency	<p>To prevent thermal overloading of the devices, the maximum permissible switching frequency must be adhered to and the correction factor tables must be used (see the installation guidelines in Section 8.3.2).</p>
Starting time	<p>In order to obtain optimum operating conditions for the 3RW3 soft starter, the setting for the starting time should be approx. 1 second longer than the resultant motor run-up time, in order to ensure that the internal jumpering contacts do not have to carry the starting current. This protects the internal jumpering contacts and increases their service life. Longer starting times increase the thermal load on the devices and the motor unnecessarily and lead to a reduction in the permissible switching frequency.</p>

Position of the terminals

3RW30

The following graphic illustrates the position of the terminals and the potentiometers for adjustment.

**Frame size S00
3RW301.**

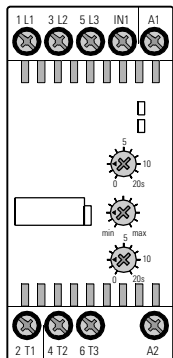

**Frame size S0 to S3
3RW302./303./304.**

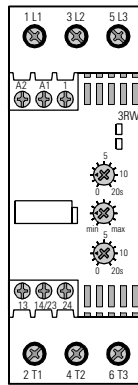

Fig. 8-17: Position of the terminals and the potentiometers for adjustment

3RW31

The 3RW31 soft starters are available in frame size S0. Outwardly, they differ from the 3RW30 in the labeling of the contacts and the terminals:

- There is no BYPASSED auxiliary contact. The free contact is used to enable the necessary drive contact IN2 to switch between the ramp times t_{R1} and t_{R2} .
- The 3RW31 does not have a coasting-down ramp. The potentiometer with which the coasting-down time is adjusted on the 3RW30 is used here to set the second ramp time t_{R2} .
- There is no ON auxiliary contact.

Line length of the control cable

To eliminate problems with the cable coupler capacitances, the control cable should be shorter than 15 m. (This is based on devices with a rated control supply voltage of UC 24 V to 50 m.)

To eliminate problems in control cables that are fed out of the cubicle, coupling links must be used.

8.3.6 Event messages and diagnostics

Event messages

READY LED	Continuous Flashing	Ready for operation while starting up or coasting down
BYPASSED LED	Continuous	Bypassed

Table 8-14: 3RW30/31 event messages

Diagnostics

Malfunction	Possible cause	Remedy
READY LED off	<ul style="list-style-type: none"> Supply voltage too low 	<ul style="list-style-type: none"> Check and adapt the supply voltage at A1, A2
No reaction to control input IN (READY LED on)	<ul style="list-style-type: none"> No supply voltage 	<ul style="list-style-type: none"> Check fuses/line contactor
	<ul style="list-style-type: none"> Phase loss 	<ul style="list-style-type: none"> Check fuses/line contactor Check voltages at L1 to L3
	<ul style="list-style-type: none"> Wrong cable connected to IN 	<ul style="list-style-type: none"> Connect to IN as shown in the graphic of the terminals
	<ul style="list-style-type: none"> No load 	<ul style="list-style-type: none"> Connect the motor
Start the motor directly (BYPASSED LED on)	<ul style="list-style-type: none"> The line voltage is switched off and on in continuous operation without operation of the control input IN 	<ul style="list-style-type: none"> Always switch the line contactor off and on in conjunction with control input IN

Table 8-15: 3RW30/31 diagnostics

8.3.7 Timing diagram

Starting and coasting-down behavior

The following timing diagram shows the switchover times when the device is switched on/off:

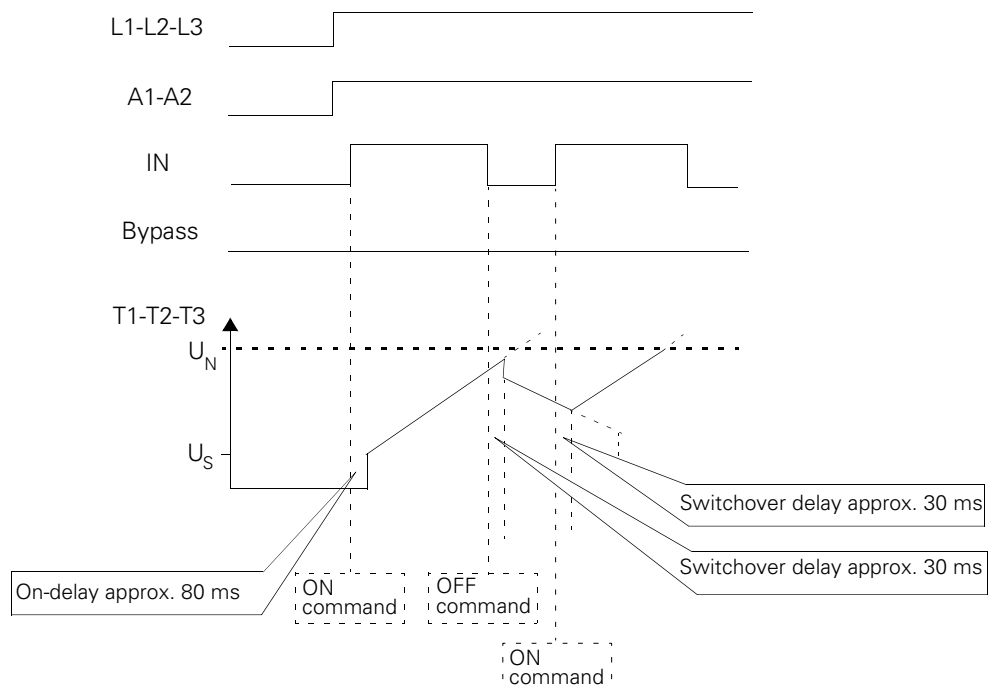

Fig. 8-18: Starting and coasting-down behavior

Supply interruption in bypassed state

If the load voltage is switched off in the bypassed state while the auxiliary supply continues to be applied at terminals A1/A2, the soft starter performs a direct start of the motor after the load voltage is switched on again. To prevent this, the "on" command must be removed in the event of the loss of the main voltage.

The following graphic illustrates what happens when the supply is interrupted in the bypassed state:

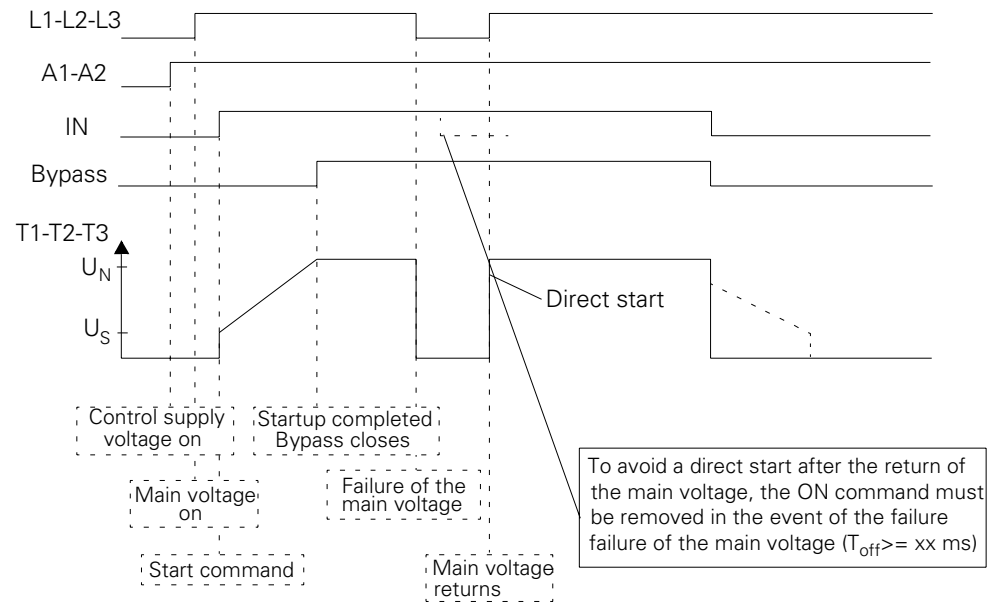

Fig. 8-19: Supply interruption in the bypassed state

8.4 Accessories

The following accessories are available for the 3RW3 soft starters:

Description	Order number
Fan for 3RW3.2..	3RW3926-8A
Fan for 3RW303.. and 3RW304..	3RW3936-8A
Terminal covers for box covers for 3RW303..	3RT1936-4EA2
Terminal covers for box covers for 3RW304..	3RT1946-4EA2
Terminal cover for bar connection for 3RW304..	3RT1946-4EA1
Link modules for combination with 3RV1 circuit breaker	3RA19.1-1A (frame sizes S00 to S3)
RC element for control from PLC	3TX7462-3T

Table 8-16: Accessories, 3RW30/31

Control of the fan

The fan is controlled by the control electronics of the soft starter.

It runs at the following times:

- When the fan is switched on: approx. 0.5 seconds after the bypass contacts close (end-of-startup signal)
- When the fan is switched off: approx. 0.5 hours after the soft starter is switched off

Attachment of the fan

The fan is snapped into the recess provided on the underside of the soft starter, and the plug-in cable is inserted in the corresponding connector. The direction of installation is indicated on the fan by an arrow.

Additional parameter assignment is not necessary.

These fan modules mean that the starter can be installed in any position.

The only exception to this is when the fan cannot blow against the convection downward from above.

Attachment of the fan

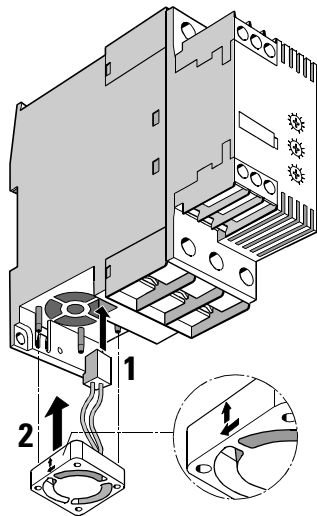

Fig. 8-20: Accessories: attachment of the fan

Terminal covers

To provide additional finger protection, for frame sizes S2 and S3 the terminal covers of the 3RT1 contactors of the same frame sizes can be used. Installation on the soft starter is analogous to that on the contactors.

Link modules

The same link modules are available for building fuseless feeders (soft starter + 3RV circuit breaker) as are used for the 3RT contactor + 3RV circuit breaker combinations. Refer to the information and assignment tables in Section 8.3.2, "Installation guidelines".

RC element

If the 3RW30/31 soft starter is to be controlled from a PLC with a Triac or thyristor output, malfunctioning can be avoided with an RC element. If there is leakage current of more than 1 mA, without an RC element the soft starter may interpret the drop in voltage that occurs at the input as an "ON" command.

Connection example for an RC element

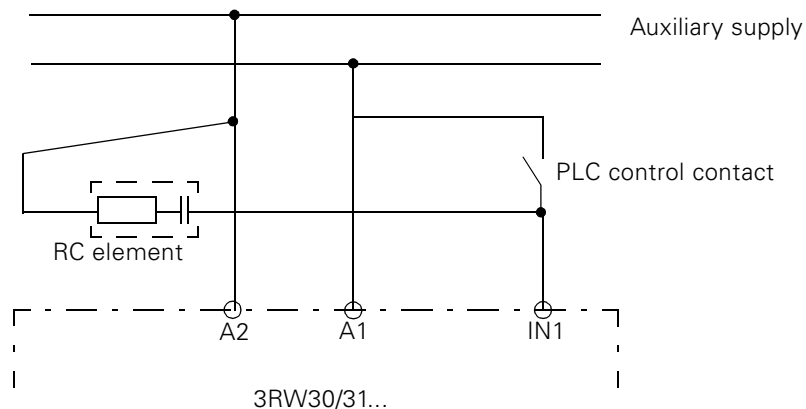

Fig. 8-21: Connection example with an RC element

8.5 Mounting and connection

8.5.1 Mounting

Snap-on attachment

The 3RW30 soft starters are snapped onto 35 mm rails in acc. with DIN EN 50 022 without a tool.

The starter is placed on the upper edge of the rail and pressed downward until it snaps onto the lower edge of the rail.

Frame sizes S00 and S0 can be removed just as easily: The starters are pressed downward so that the tension of the attachment springs is loosened, and the starters can be removed.

In the case of frame sizes S2 and S3, these attachment springs are released by a lug on the underside of the starter that can be moved using a screwdriver.

8.5.2 Connection

Screw-type terminals

The 3RW3 electronic soft starters are available with the SIGUT[®] terminal system and plus-minus POZIDRIV 2 screws.

Conductor cross-sections

The following table shows the permissible conductor cross-sections for the 3RW30 electronic soft starters:









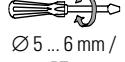

	3RW301. L1 L2 L3 A1/A2; NO/NC	3RW302. 3RW312. L1 L2 L3		3RW303. L1 L2 L3		3RW304.. L1 L2 L3
 Ø 5 ... 6 mm / PZ2	0.8 to 1.2 Nm 7 to 10.3 lb.in	2 to 2.5 Nm 18 to 22 lb.in	 Ø 5 ... 6 mm / PZ2	3 to 4.5 Nm 27 to 40 lb.in		4 to 6 Nm 35 to 53 lb.in
	2 x (0.5 to 1.5 mm ²) 2 x (0.75 to 2.5 mm ²)	2 x (1 to 2.5 mm ²) 2 x (2.5 to 6 mm ²)		2 x (0.75 to 16 mm ²)		2 x (2.5 to 16 mm ²)
	2 x (0.5 to 2.5 mm ²)	2 x (1 to 2.5 mm ²) 2 x (2.5 to 6 mm ²)		2 x (0.75 to 16 mm ²) 1 x (0.75 to 25 mm ²)		2 x (2.5 to 35 mm ²) 1 x (2.5 to 50 mm ²)
—	—	—		2 x (0.75 to 25 mm ²) 1 x (0.75 to 35 mm ²)		2 x (10 to 50 mm ²) 1 x (10 to 70 mm ²)
AWG	2 x (18 to 14)	2 x (14 to 10)	AWG	2 x (18 to 3) 1 x (18 to 2)	AWG	2 x (10 to 1/0) 1 x (10 to 2/0)

Table 8-17: Conductor cross-sections, 3RW30/31

8.5.3 Circuit diagrams

There are two ways to connect up the 3RW3 soft starter:

- Control by button and locking of the ON button via the "ON" auxiliary contact of the 3RW3
- Control by switch

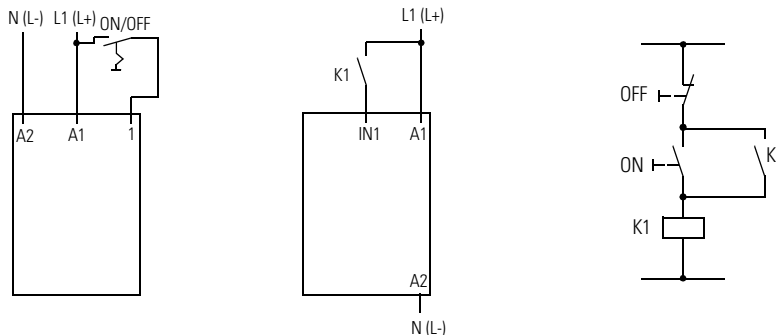

Fig. 8-22: Circuit diagrams, 3RW3

L3RW30

3RW302.
3RW303./3RW304

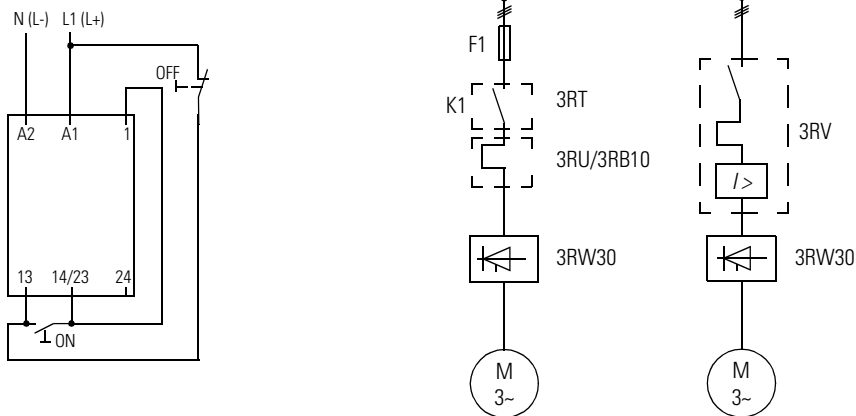

Fig. 8-23: Circuit diagrams, 3RW30

3RW31

Fig. 8-24: Circuit diagrams, 3RW31

Automatic operation

Direct starting of the soft starter is possible as long as the auxiliary supply is applied at terminals A1 and A2. To this end, a jumper is required between the auxiliary supply contact A1 and the control contact IN.

The following must be taken into consideration:

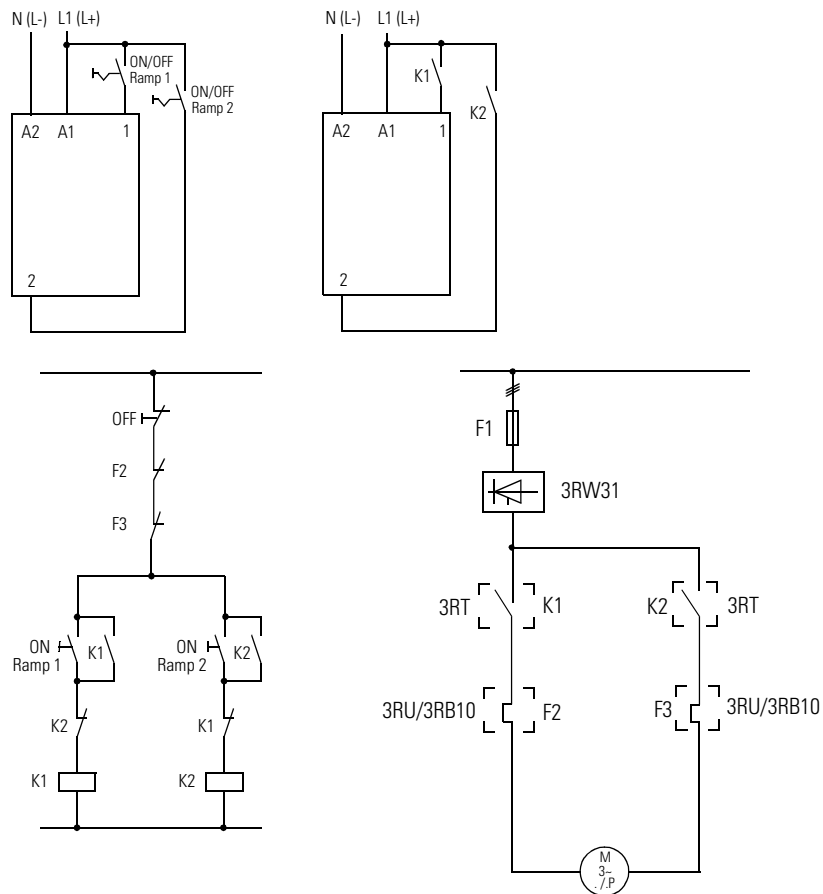
- An on delay of up to 4 seconds can occur, depending on the frame size.
- Soft coasting down is no longer possible after the auxiliary supply is switched off.

Control via PLC

The 3RW3 soft starter can be controlled by means of a programmable controller (PLC). It is connected up in the same way as for control via switch.

Important

Always ensure that A1 and A2 are connected up correctly. Although polarity reversal cannot damage the device, it can lead to malfunctioning.

Control of a motor with an electromechanical brake

An electromechanical brake with infeed from the main voltage (L1/L2/L3) should not be connected directly to the output of the soft starter. An electromechanical brake should be controlled by means of a separate contactor (K1 in the circuit diagram below):

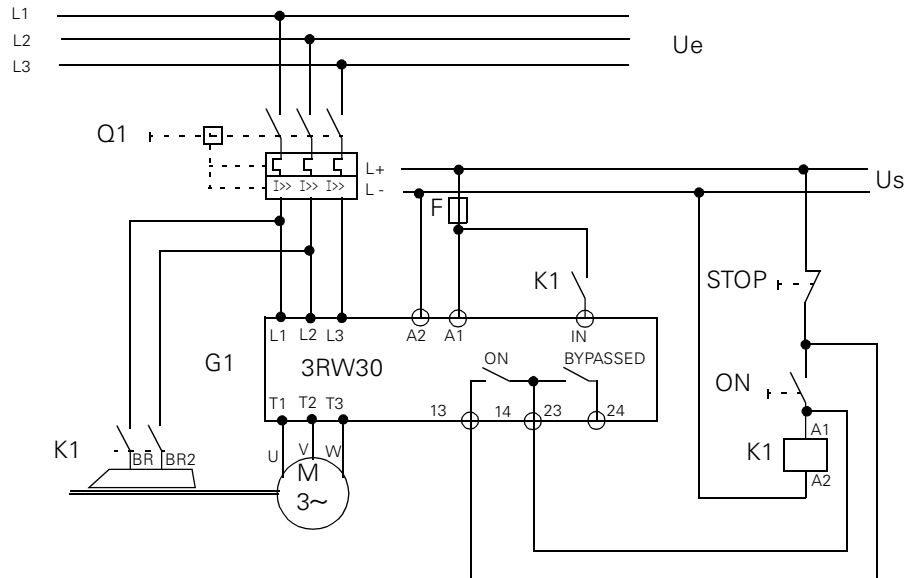
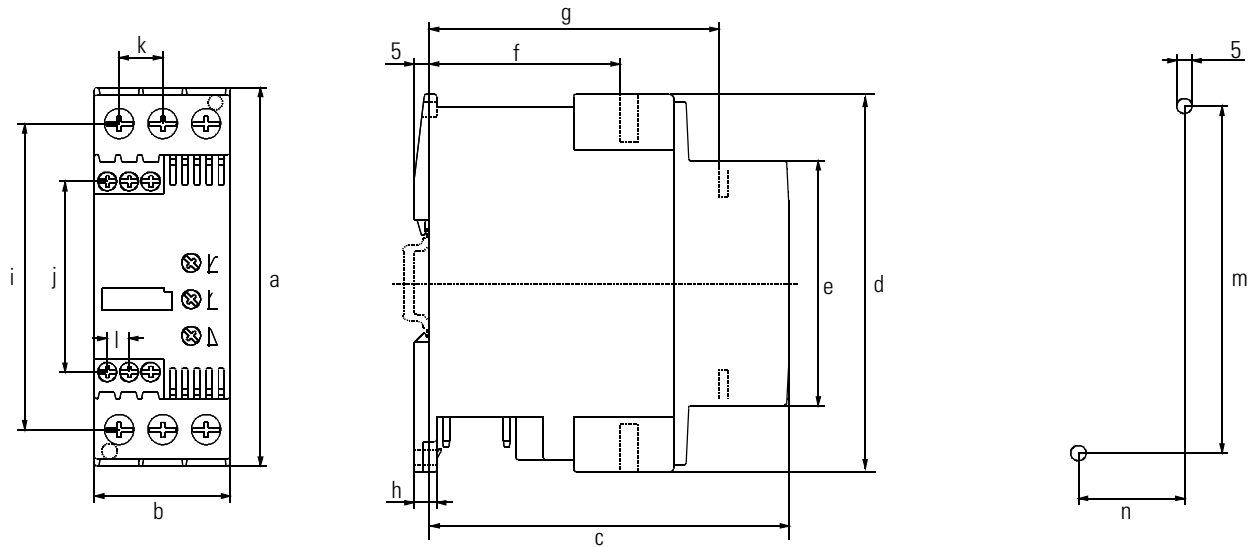

Fig. 8-25: Motor control with an electromechanical brake

8.6 Dimensioned drawings (dimensions in mm)



mm	a	b	c	d	e	f	g	h	i	j	k	l	m	n
3RW301.	97.5	45	93	95	66	51	—	7.5	76	—	86	—	90	35
3RW302./3RW312.	125	45	119	125	81	63	96	7	101	63	14	7	115	35
3RW303.	160	55	143	141	95	63	115	8	119	77	18	7	150	30
3RW304.	170	70	183	162	108	87	156	8	132	87	22.5	7	160	60

8.7 Technical specifications

8.7.1 Control electronics/power electronics

Control electronics

Type	3RW3. ...-1.B0.		3RW3. ...-1.B1.
Rated control supply voltage	V	UC 24	
Rated control supply current	mA	Approx. 50	Approx. 25 to 20
Rated frequency at AC	Hz	50/60 ± 10 %	

Power electronics

Type	3RW3. ...-1.B.4		3RW3. ...-1.B.5	3RW30 ...-1AA12
Voltage operating range	V	200 AC to 460 AC, three-phase (± 10 %)	460 AC to 575 AC, three phase (± 10 % - 15 %)	115 AC to 240 AC, single-phase (±10 %)
Rated frequency	Hz	50/60 ± 10 %		
Permissible site altitude	Reduction of I_E			
	• Up to 1000 m above sea level	100 %		
	• Up to 2000 m above sea level	92 %		
	• Up to 3000 m above sea level	85 %		
	• Up to 4000 m ab. sea level ¹⁾	78 %		
Installation position	Without additional fan With additional fan ³⁾	The soft starters are designed for operation when mounted in a vertical position. Any installation position (except vertical rotated by 180 °)		

Type	3RW30 1.	3RW3. 2.	3RW30 3.	3RW30 4.
Frame size	S00	S0	S2	S3
Continuous operation (% of I_E)	%	100		
Minimum load ²⁾ (% of I_E); At 40 °C	%	4		
Permissible ambient temperature	°C	-25 to +60 (derating as of 40 °C, see below)		
Switching capacity of the auxiliary contacts	230 V/AC-15 230 V/DC-13 24 V/DC-13	A ⁴⁾ A ⁴⁾ A ⁴⁾	3 0.1 1	3 0.1 1

Type	3RW30 14	3RW30 16	3RW30 24	3RW30 25	3RW30 26	
Current-carrying capacity						
Rated operational current I_E in acc. with IEC	At 40/50/60 °C, AC-53b	A 6/5/4	9/8/7	12.5/11/9	16/14/12	25/21/18
Rated operational current I_E in acc. with UL/CSA	At 40/50/60 °C, AC-53b	A 4.8/4.8/4	7.8/7.8/7	11/11/9	17.5/14/12	25/21/18
Power loss at continuous rated operational current (40 °C) approx.	W	5	7	7	9	13
Power loss when the max. switching frequency is exploited	W	5	6	7	8	9
Permissible starts per hour without the use of a fan						
Given intermittent duty S4, $T_U = 40$ °C	1/h	60	40	30		12
Duty cycle = 30%; stand-alone installation	%	250 x I_E , 2 s		300 x I_E , 2 s		
Permissible starts per hour with the use of a fan						
Given intermittent duty S4, $T_U = 40$ °C	1/h	— ³⁾		54		21
Duty cycle = 30%; stand-alone installation						
Idle time after continuous operation	s	0				200
With I_E before a new start						
Degree of protection	In acc. with IEC 60 529	IP20 (terminal housing IP00)				

Conductor cross-sections**Screw-type terminals**

(1 or 2 conductors connectable)
for standard screwdrivers
size 2 and Pozidriv 2

Auxiliary conductors:

• Single-core	mm ²	2 x (0.5 to 1.5); 2 x (0.75 to 2.5) in acc. with IEC 60 947; max. 2 x (0.75 to 4)
• Finely stranded with wire end ferrule	mm ²	2 x (0.5 to 1.5); 2 x (0.75 to 2.5)
• AWG cables, single- or multi-core	AWG	2 x (18 to 14) M 3, PZ2
- Terminal screws	Nm	0.8 to 1.0
- Tightening torque	lb.in	7.1 to 8.9

Main conductors:

• Single-core	mm ²	2 x (0.5 to 1.5); 2 x (0.75 to 2.5)	2 x (1 to 2.5) 2 x (2.5 to 6)
• Finely stranded with wire end ferrule	mm ²	2 x (0.5 to 2.5)	2 x (1 to 2.5) 2 x (2.5 to 6)
• Multi-core	mm ²	—	—

Type		3RW30 14	3RW30 16	3RW30 24	3RW30 25	3RW30 26
• AWG cables, single- or multi-core	AWG	2 x (18 to 14)		2 x (14 to 10)		
- Terminal screws		M 3, PZ2		M 4, PZ2		
- Tightening torque	Nm	0.8 to 1.2		2 to 2.2		
	lb.in	7 to 10.3		18 to 22		

1)Over 4000 m on request

2)The rated current for the motor (specified on the motor's type plate) should amount at least to the specified percentage of the SIRIUS soft starter's device rated current I_e .

3)In the case of frame size S00, it is not possible to install the fan provided as an accessory.

4)Frame size S00 does not have any auxiliary contacts.

Power electronics

Type		3RW30 34	3RW30 35	3RW30 36	3RW30 44	3RW30 45	3RW30 46
Current-carrying capacity							
Rated operational current I_e in acc. with IEC	At 40/50/60 °C, AC-53b	A	32/27/23	38/32/27	45/38/32	63/54/46	75/64/54
Rated operational current I_e in acc. with UL/CSA	At 40/50/60 °C, AC-53b	A	27/27/23	34/32/27	42/38/32	62/54/46	68/64/54
Power loss at continuous rated operational current (40 °C) approx.	W	10	13	17	13	16	26
Permissible starts per hour							
Given interm. duty S4, $T_u = 40$ °C	1/h	20	15	5	20	30	15
Duty cycle = 30 %	%	300 x I_e , 3 s			300 x I_e , 4s		
Permissible starts per hour with the use of a fan							
Given interm. duty S4, $T_u = 40$ °C	1/h	44	27	9	32	48	24
Duty cycle = 30 %; stand-alone installation							
Idle time after cont. operation with I_e before a new start	s	0		400	0		
Degree of protection	In acc. with IEC 60 529	IP20 (terminal housing IP00)			IP20 ¹⁾		

Conductor cross-sections

Screw-type terminals

(1 or 2 conductors connectable)
for standard screwdrivers

size 2 and Pozidriv 2

Auxiliary conductors:

- Single-core mm² 2 x (0.5 to 1.5); 2 x (0.75 to 2.5) in acc. with IEC 60 947; max. 2 x (0.75 to 4)
- Finely stranded with wire end ferrule mm² 2 x (0.5 to 1.5); 2 x (0.75 to 2.5)
- AWG cables, single- or multi-core AWG 2 x (18 to 14)
- Terminal screws M 3
- Tightening torque Nm 0.8 to 1.0
lb.in 7.1 to 8.9

Main conductors:

- Single-core mm² 2 x (0.75 to 16)
- Finely stranded with wire end ferrule mm² 2 x (0.75 to 16)
1 x (0.75 to 25)
- Multi-core mm² 2 x (0.75 to 25) 2 x (10 to 50)
1 x (0.75 to 35) 1 x (10 to 70)
- AWG cables, single- or multi-core AWG 2 x (18 to 3) 2 x (10 to 1/0)
1 x (18 to 2) 1 x (10 to 2/0)
- Terminal screws M 6, box terminal, PZ2 M6 (Allan screw)
- Tightening torque Nm 3 to 4.5 4 to 6
lb.in 27 to 40 35 to 53

General specifications

	Standard	Parameters
EMC noise immunity		
Electrostatic discharge (ESD)	IEC 1000-4-2,	Severity 3: 6/8 kV
El. magn. RF fields	IEC 1000-4-3	Frequency range: 80 to 1000 MHz with 80 % at 1 kHz Severity 3, 10 V/m
Conducted RF disturbance	IEC 61000-4-6 EN 60 947-4-2 SN-IACS	Frequency range: 80 MHz to 1000 MHz with 80 % at 1 kHz 10 V at 0.15 MHz to 80 MHz 3 V at 10 kHz to 80 MHz
Burst	IEC 1000-4-4	Severity 3: 1/2 kV
Surge	IEC 1000-4-5	Severity 3: 1/2 kV
EMC emitted interference		
EMC radio interference intensity	CISPR 11/09.1990	Limit value of class B at 30 MHz to 1000 MHz
Radio interference voltage	CISPR 11/09.1990 EN 60 947-4-2	(0.15 MHz to 30 MHz): device class A (industry)

¹⁾ IP20 only with attached box terminal (delivery state). Without box terminal IP00.

²⁾ Device class B (public power supply networks) is complied with only in the case of variants 3RW3.-1AB0. with control supply voltage UC of 24 V. For the 3RW3.-1A.1. variants with a control supply voltage UC of 110 V to 230 V, single-stage filters (e.g. type B84143-A...) must be connected upstream.

8.7.2 Short-circuit protection and fuse coordination

IEC 60947-4-1/DIN VDE 0660 Part 102 draws a distinction between two coordination types, known as coordination type 1 and coordination type 2. In both coordination types, the short circuit to be dealt with is reliably disconnected. The differences lie only in the degree to which the device is damaged after a short circuit.

Coordination type 1

The motor feeder can be operable after each short-circuit disconnection. Damage to the soft starter is possible. The circuit breaker itself always attains coordination type 1.

Coordination type 2

After a short-circuit event there must be no damage to the soft starter or any other switching device; only the backup fuse may be destroyed. The actual motor feeder can be put into operation again immediately once the short circuit fuse has been replaced.

Maximum short-circuit current

All the specified fuse configurations are designed for a maximum short-circuit current of 50 kA. This ensures that short circuits of 50 kA can be disconnected without posing a threat to persons or the system.

Motor feeder: coordination type 1

Note on configuration

A fuseless configuration is recommended for motor feeders (i.e. the combination of a 3RV circuit breakers and a 3RW30 soft starter). Coordination type 1 is thus attained.

Motor feeder: coordination type 2

To set up a motor feeder of coordination type 2, the feeder must be fused (i.e. the motor must be provided with overload protection).

The following can be used:

- The 3NE1 all-range fuse, which unifies line protection and semiconductor protection
- The 3NE8 semiconductor protection fuse, in which case additional protection must be provided for the line

Comparison of coordination types 1 and 2

The configuration variant on the basis of coordination type 2 is associated with higher costs than that of coordination type 1, which is why the fuseless configuration (coordination type 1) is recommended. The advantages are:

- Fewer components in the cubicle
- Less effort required for wiring
- Less cubicle space required
- Lower price

**Fuse configurations
with SITOR 3NE1..-0**

The following table specifies the fuse configuration (coordination type 2) for 3RW30/31 with SITOR fuses 3NE1..-0 (short-circuit and line protection); max. short-circuit current 50 kA:

Order number Soft starter	Order number of the fuse	Rated current of the fuse	Frame size of the fuse
MLFB	MLFB	A	
3RW30 14	3NE1814-0 ¹⁾	20	000
3RW30 16	3NE1815-0 ¹⁾	25	000
3RW30 24/3RW31 24	3NE1815-0 ²⁾	25	000
3RW30 25/3RW31 25	3NE1815-0 ²⁾	25	000
3RW30 26/3RW31 26	3NE1802-0 ²⁾	40	000
3RW30 34	3NE1818-0 ²⁾	63	000
3RW30 35	3NE1820-0 ²⁾	80	000
3RW30 36	3NE1820-0 ²⁾	80	000
3RW30 44	3NE1820-0 ²⁾	80	000
3RW30 45	3NE1021-0 ²⁾	100	00
3RW30 46	— ³⁾	—	—

Table 8-18: Fuse configurations (SITOR)

1) Fuse coordination for max. 400 V

2) Fuse coordination for max. 500 V

3) Fuse coordination with all-range fuses not possible;
pure semiconductor protection fuses plus circuit breakers
can be used instead (see following table)

Fuse configurations with SITOR 3NE8

The following table specifies the fuse configuration (coordination type 2) for 3RW30/31 with SITOR fuses 3NE8 (semiconductor protection is provided by the fuse; line protection and overload protection are provided by the circuit breaker); max. short-circuit current 50 kA/400 V:

Order number Soft starter	Order number of the fuse	Rated current of the fuse	Frame size of the fuse	Order number of the circuit breaker ²⁾	Link module 3RW - 3RV
MLFB	MLFB	A	Size	MLFB	MLFB ³⁾
3RW30 14	3NE80 03	35	00	3RV10 11	3RA19 11-1A
3RW30 16	3NE80 03	35	00	3RV10 11	3RA19 11-1A
3RW30 24/ 3RW31 24	3NE80 03	35	00	3RV10 21	3RA19 21-1A
3RW30 25/ 3RW31 25	3NE80 03	35	00	3RV10 21	3RA19 21-1A
3RW30 26/ 3RW31 26	— ¹⁾	—	—	—	—
3RW30 34	3NE80 22	125	00	3RV10 31	3RA19 31-1A
3RW30 35	3NE80 24	160	00	3RV10 31	3RA19 31-1A
3RW30 36	3NE80 24	160	00	3RV10 31	3RA19 31-1A
3RW30 44	3NE80 24	160	00	3RV10 41	3RA19 41-1A
3RW30 45	3NE80 24	160	00	3RV10 41	3RA19 41-1A
3RW30 46	3NE80 24	160	00	3RV10 41	3RA19 41-1A

Table 8-19: Fuse configurations (SITOR)

- 1) Coordination with pure semiconductor protection fuses is not possible; all-range fuses 3NE1..-0 can be used (see the table above)
- 2) The selection and setting of the circuit breaker is based on the rated current for the motor
- 3) Note the unit of quantity

If the motor is to be configured to meet UL requirements, the order number of the fuse must be specified (3NE80..-1).

Fuseless configuration

The following table specifies the components of the fuseless configuration (coordination type 1) for 3RW30/31; short-circuit current of 50 kA/400 V:

Order number of the soft starter	Order number of the circuit breaker ¹⁾	Link module
MLFB	MLFB	MLFB ³⁾
3RW30 14	3RV10 11 ²⁾	3RA19 11-1A
3RW30 16	3RV10 11 ²⁾	3RA19 11-1A
3RW30 24/ 3RW31 24	3RV10 21	3RA19 21-1A
3RW30 25/ 3RW31 25	3RV10 21	3RA19 21-1A
3RW30 26/ 3RW31 26	3RV10 21	3RA19 21-1A
3RW30 34	3RV10 31	3RA19 31-1A
3RW30 35	3RV10 31	3RA19 31-1A
3RW30 36	3RV10 31	3RA19 31-1A
3RW30 44	3RV10 41	3RA19 41-1A
3RW30 45	3RV10 41	3RA19 41-1A
3RW30 46	3RV10 41	3RA19 41-1A

Table 8-20: Motor feeder: fuseless configuration

- 1) The selection and setting of the circuit breaker is based on the rated current for the motor
- 2) 50 mm clearance is required above and below between the 3RW and grounded parts
- 3) Note the unit of quantity

Fused configuration

The following table specifies the components of the fused configuration (coordination type 1) for 3RW30/31; short-circuit current of 50 kA/400 V:

Order number of the soft starter	Order number of the fuse	Fuse rated current/ frame size	Order number of the therm. overload relay ¹⁾	Order number of the electron. overload relay ¹⁾	Order number of the contactor
MLFB	MLFB	A / size	MLFB	MLFB	MLFB
3RW30 14	3NA38 10	25 / 00	3RU11 16 ²⁾⁴⁾	3RB10 16 ²⁾⁴⁾	3RT10 15
3RW30 16	3NA38 10	25 / 00	3RU11 16 ²⁾⁴⁾	3RB10 16 ²⁾⁴⁾	3RT10 16
3RW30 24/ 3RW31 24	3NA38 22	63 / 00	3RU11 26 ³⁾	3RB10 26 ³⁾	3RT10 24
3RW30 25/ 3RW31 25	3NA38 22	63 / 00	3RU11 26 ³⁾	3RB10 26 ³⁾	3RT10 25
3RW30 26/ 3RW31 26	3NA38 24	80 / 00	3RU11 26 ³⁾	3RB10 26 ³⁾	3RT10 26
3RW30 34	3NA38 30	100 / 00	3RU11 36 ³⁾		3RT10 34
3RW30 35	3NA38 30	100 / 00	3RU11 36 ³⁾		3RT10 35
3RW30 36	3NA38 30	100 / 00	3RU11 36 ³⁾		3RT10 36
3RW30 44	3NA31 44	250 / 1	3RU11 46 ³⁾		3RT10 44
3RW30 45	3NA31 44	250 / 1	3RU11 46 ³⁾		3RT10 45
3RW30 46	3NA31 44	250 / 1	3RU11 46 ³⁾		3RT10 46

Table 8-21: Motor feeder: fused configuration

- 1) The selection and setting of the overload relay is based on the rated current for the motor
- 2) Short-circuit current of 50 kA to max. 400 V
- 3) Short-circuit current of 50 kA to max. 500 V
- 4) 50 mm clearance is required above and below between the 3RW and grounded parts

8.7.3 Site altitude

If the site altitude is above 1000 m, the following are necessary:

- A reduction in the rated current for thermal reasons
- A reduction in the rated voltage on account of the diminished dielectric strength

Reductions as a function of site altitude

The diagram below plots the reductions in rated current and rated operating voltage as a function of site altitude:

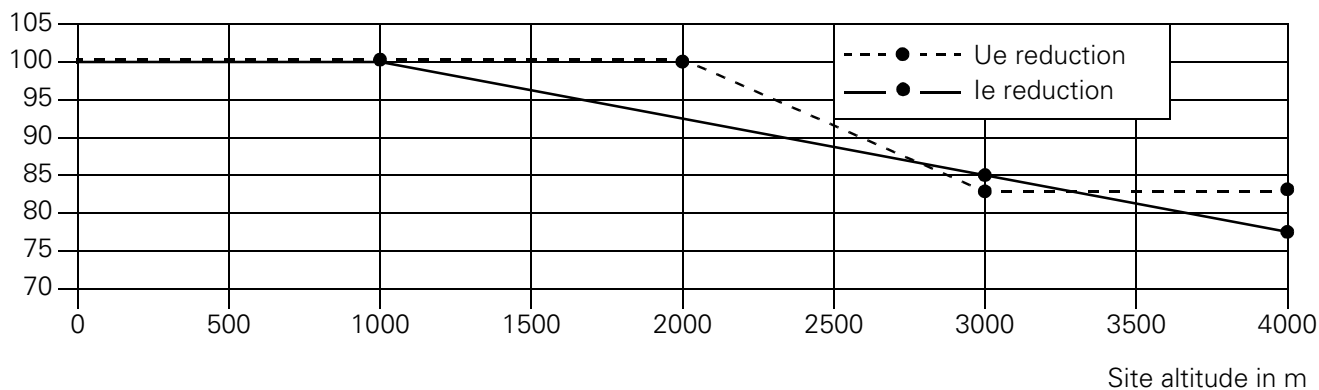

Fig. 8-26: Reductions as a function of site altitude

8.7.4 Specifications in acc. with IEC

The specified motor ratings are guide values.

The soft starter must be selected on the basis of the rated current I_e .

The motor ratings are based on the values specified in DIN 42 973 (kW) and NEC 96 / UL 508 (hp).

Ambient temperature = 40 °C

230 V	400 V	I_e	Order number	500 V	I_e	Order number
Pe in kW	Pe in kW	In A	MLFB	Pe in kW	In A	MLFB
1.5	3	6	3RW30 14-1CB.4	—	—	—
2.2	4	9	3RW30 16-1CB.4	—	—	—
3	5.5	12.5	3RW30 24-1AB.4	7.5	12.5	3RW30 24-1AB.5
4	7.5	16	3RW30 25-1AB.4	7.5	16	3RW30 25-1AB.5
5.5	11	25	3RW30 26-1AB.4	15	25	3RW30 26-1AB.5
7.5	15	32	3RW30 34-1AB.4	18.5	32	3RW30 34-1AB.5
11	18.5	38	3RW30 35-1AB.4	22	38	3RW30 35-1AB.5
11	22	45	3RW30 36-1AB.4	30	45	3RW30 36-1AB.5
19	30	63	3RW30 44-1AB.4	37	63	3RW30 44-1AB.5
22	37	75	3RW30 45-1AB.4	45	75	3RW30 45-1AB.5
30	55	100	3RW30 46-1AB.4	70	100	3RW30 46-1AB.5

Table 8-22: 3RW3 motor ratings in acc. with IEC at 40 °C

Ambient temperature = 50 °C

230 V	400V	I_e	Order number	500 V	I_e	Order number
Pe in kW	Pe in kW	In A	MLFB	Pe in kW	In A	MLFB
1.1	2.2	5	3RW30 14-1CB.4	—	—	—
1.5	4	8	3RW30 16-1CB.4	—	—	—
3	5.5	11	3RW30 24-1AB.4	5.5	11	3RW30 24-1AB.5
4	5-5	14	3RW30 25-1AB.4	7.5	14	3RW30 25-1AB.5
5.5	11	21	3RW30 26-1AB.4	11	21	3RW30 26-1AB.5
7.5	11	27	3RW30 34-1AB.4	15	27	3RW30 34-1AB.5
7.5	15	32	3RW30 35-1AB.4	18.5	32	3RW30 35-1AB.5
11	18.5	38	3RW30 36-1AB.4	22	38	3RW30 36-1AB.5
15	22	54	3RW30 44-1AB.4	30	54	3RW30 44-1AB.5
18.5	30	64	3RW30 45-1AB.4	37	64	3RW30 45-1AB.5
22	45	85	3RW30 46-1AB-4	55	85	3RW30 46-1AB.5

Table 8-23: 3RW3 motor ratings in acc. with IEC at 50 °C

Ambient temperature = 60 °C

230 V	400 V	I_e	Order number	500 V	I_e	Order number
Pe in kW	Pe in kW	In A	MLFB	Pe in kW	In A	MLFB
0.75	1.5	4	3RW30 14-1CB.4	—	—	—
1.5	3	7	3RW30 16-1CB.4	—	—	—
2.2	4	9	3RW30 24-1AB.4	5.5	9	3RW30 24-1AB.5
3	5.5	12	3RW30 25-1AB.4	7.5	12	3RW30 25-1AB.5
4	7.5	18	3RW30 26-1AB.4	11	18	3RW30 26-1AB.5
5.5	11	23	3RW30 34-1AB.4	15	23	3RW30 34-1AB.5
7.5	11	27	3RW30 35-1AB.4	15	27	3RW30 35-1AB.5
7.5	15	32	3RW30 36-1AB.4	18.45	32	3RW30 36-1AB.5
11	22	46	3RW30 44-1AB.4	30	46	3RW30 44-1AB.5
15	22	54	3RW30 45-1AB.4	30	54	3RW30 45-1AB.5
18.5	37	72	3RW30 46-1AB.4	45	72	3RW30 46-1AB.5

Table 8-24: 3RW3 motor ratings in acc. with IEC at 60 °C

8.7.5 Specifications in acc. with NEMA

The specified motor ratings are guide values.

The soft starter must be selected on the basis of the rated current I_e .

The motor ratings are based on the values specified in DIN 42 973 (kW) and NEC 96 / UL 508 (hp).

Ambient temperature = 40 °C

200V	230 V	460V	I_e	Order number	460V	575V	I_e	Order number
Pe in hp	Pe in hp	Pe in hp	In A	MLFB	Pe in hp	Pe in hp	In A	MLFB
1	1	3	4.8	3RW30 14-1CB.4	—	—	—	—
2	2	5	7.8	3RW30 16-1CB.4	—	—	—	—
3	3	7.5	11	3RW30 24-1AB.4	7.5	10	11	3RW30 24-1AB.5
5	5	10	17.5	3RW30 25-1AB.4	10	15	17.5	3RW30 25-1AB.5
7.5	7.5	15	25.3	3RW30 26-1AB.4	15	20	25.3	3RW30 26-1AB.5
7.5	7.5	20	27	3RW30 34-1AB.4	20	25	27	3RW30 34-1AB.5
10	10	25	34	3RW30 35-1AB.4	25	30	34	3RW30 35-1AB.5
10	15	30	42	3RW30 36-1AB.4	30	40	42	3RW30 36-1AB.5
20	20	40	62.1	3RW30 44-1AB.4	40	60	62.1	3RW30 44-1AB.5
20	25	50	68	3RW30 45-1AB.4	50	60	68	3RW30 45-1AB.5
30	30	75	99	3RW30 46-1AB.4	75	100	99	3RW30 46-1AB.5

Table 8-25: 3RW3 motor ratings in acc. with NEMA at 40 °C

Ambient temperature = 50 °C

200V	230 V	460V	I_e	Order number	460V	575V	I_e	Order number
Pe in hp	Pe in hp	Pe in hp	In A	MLFB	Pe in hp	Pe in hp	In A	MLFB
1	1	3	4.8	3RW30 14-1CB.4	—	—	—	—
2	2	5	7.8	3RW30 16-1CB.4	—	—	—	—
3	3	7.5	11	3RW30 24-1AB.4	7.5	10	11	3RW30 24-1AB.5
3	3	10	14	3RW30 25-1AB.4	10	10	14	3RW30 25-1AB.5
5	5	15	21	3RW30 26-1AB.4	15	15	21	3RW30 26-1AB.5
7.5	7.5	20	27	3RW30 34-1AB.4	20	25	27	3RW30 34-1AB.5
7.5	10	20	32	3RW30 35-1AB.4	20	30	32	3RW30 35-1AB.5
10	10	25	38	3RW30 36-1AB.4	25	30	38	3RW30 36-1AB.5
15	20	40	54	3RW30 44-1AB.4	40	50	54	3RW30 44-1AB.5
20	20	40	64	3RW30 45-1AB.4	40	60	64	3RW30 45-1AB.5
25	30	60	85	3RW30 46-1AB.4	60	75	85	3RW30 46-1AB.5

Table 8-26: 3RW3 motor ratings in acc. with NEMA at 50 °C

Ambient temperature = 60 °C

200 V	230 V	460 V	I_e	Order number	460 V	575 V	I_e	Order number
Pe in hp	Pe in hp	Pe in hp	In A	MLFB	Pe in hp	Pe in hp	In A	MLFB
0.75	0.75	2	4	3RW30 14-1CB.4	—	—	—	—
1.5	1.5	3	7	3RW30 16-1CB.4	—	—	—	—
2	2	5	9	3RW30 24-1AB.4	5	7.5	9	3RW30 24-1AB.5
3	3	7.5	12	3RW30 25-1AB.4	7.5	10	12	3RW30 25-1AB.5
5	5	10	18	3RW30 26-1AB.4	10	15	18	3RW30 26-1AB.5
5	7.5	15	23	3RW30 34-1AB.4	15	20	23	3RW30 34-1AB.5
7.5	7.5	20	27	3RW30 35-1AB.4	20	25	27	3RW30 35-1AB.5
7.5	10	20	32	3RW30 36-1AB.4	20	30	32	3RW30 36-1AB.5
10	15	30	46	3RW30 44-1AB.4	30	40	46	3RW30 44-1AB.5
15	20	40	54	3RW30 45-1AB.4	40	50	54	3RW30 45-1AB.5
20	25	50	72	3RW30 46-1AB.4	50	60	72	3RW30 46-1AB.5

Table 8-27: 3RW3 motor ratings in acc. with NEMA at 60 °C